



Sri Shridevi Charitable Trust (R.)

SHRIDEVI INSTITUTE OF ENGINEERING AND TECHNOLOGY

Sira Road, Tumkur - 572 106, Karnataka, India.

Phone: 0816 - 2212629 | Principal: 0816 - 2212627, 9686114899 | Telefax: 0816 - 2212628

Email: info@shrideviengineering.org, principal@shrideviengineering.org | Website: www.shrideviengineering.org

(Approved by AICTE, New Delhi, Recognised by Govt. of Karnataka and Affiliated to Visvesvaraya Technological University, Belagavi)

ANNUAL INTER DEPARTMENTAL CULTURAL ACTIVITIES 2018-19

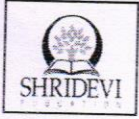

**Shridevi Institute of Engineering and Technology,
Tumkur - 572106**

Ref: SIET/Office/2018-19/

Date: 30-10-2018

CIRCULAR

It is here by informed to all the Cultural Co-ordinators (from each dept) and student Cultural Co-ordinators, both boys and girls have to attend the meeting in the eve of Annual Cultural activities for the Academic year 2018-19. I request all to assemble in Room 105 at 10-00 Am on 31-10-2017 without fail.

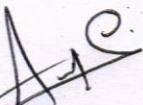
(Prof. Aijaz Ahamed Sharief)

Cultural Coordinator

PRINCIPAL
SIET, TUMKUR
(Dr. Hemadri Naidu.T)

PRINCIPAL

Copy to HODs: BT/CS/EC/EE/ME/IS/CIVIL/MBA/ Academic coordinator / Office

**Shridevi Institute of Engineering and Technology,
Tumkur - 572106**

Ref: SIET/CULTURAL/2018-19

Date: 31-10-2018

CIRCULAR

It is here by informed to all the Department HODs Staffs Cultural Co-ordinators & student cultural Co-ordinators, Cultural activities Schedule on 2nd & 3rd of November 2018.

1. Solo Song
2. Group Song
3. Skit
4. Quiz
5. Drama
6. Mime
7. MAD ADS

Copy to HODs: CS/EC/EE/ME/IS/CIVIL/MBA/First Year/ Academic coordinator/Office/ Shri Utsav Co-ordinator

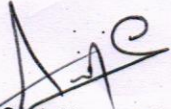
(Prof. Aijaz Ahamed Sharief)

Cultural Coordinator



PRINCIPAL
SIET, TUMKUR

(Dr. Hemadri Naidu.T)

PRINCIPAL



Shridevi Institute of Engineering and Technology,
Tumkur - 572106



DEPARTMENT OF CIVIL ENGINEERING

Date: 31-10-2018

It is here by sending list of students participating in Annual Inter department Cultural activities for the following events

1. Solo Song
2. Group Song
3. Skit
4. Quiz
5. Drama
6. Super Minit
7. Mime
8. MAD ADS

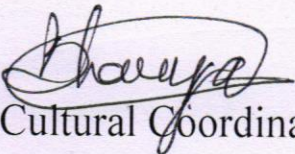
Cultural Coordinator

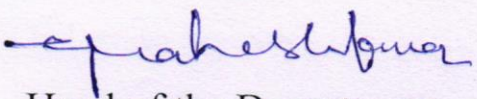
Head of the Department
HOD
Dept. of Civil Engineering
SIET, TUMKUR - 6.

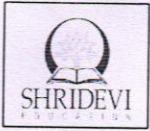

DEPARTMENT OF COMPUTER SCIENCE & ENGINEERING

Date: 01-11-2018

It is here by sending list of students participating in Annual Inter department Cultural activities for the following events

1. Solo Song
2. Group Song
3. Skit
4. Quiz
5. Drama
6. Super Minit
7. Mime
8. MAD ADS

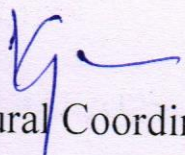
Cultural Coordinator

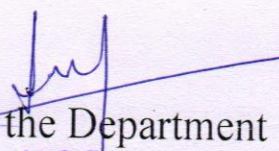
Head of the Department
HOD,
COMPUTER SCIENCE & ENGG.,
SIET, TUMAKURU-06.



Shridevi Institute of Engineering and Technology,
Tumkur - 572106



DEPARTMENT OF MECHANICAL ENGINEERING

Date: 01-11-2018

It is here by sending list of students participating in Annual Inter department Cultural activities for the following events

1. Solo Song
2. Group Song
3. Skit
4. Quiz
5. Drama
6. Super Minit
7. Mime
8. MAD ADS

Cultural Coordinator

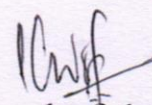
Head of the Department

H.O.D
Dept. of Mechanical
S.I.E.T., TUMKUR -6



Shridevi Institute of Engineering and Technology,
Tumkur - 572106



**DEPARTMENT OF ELECTRONICS & COMMUNICATION
ENGINEERING**

Date: 31-10-2018

It is here by sending list of students participating in Annual Inter department Cultural activities for the following events

1. Solo Song
2. Group Song
3. Skit
4. Quiz
5. Drama
6. Super Minit
7. Mime
8. MAD ADS

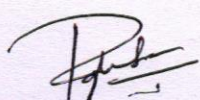
Cultural Coordinator

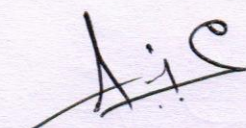
Head of the Department

HOD
Dept of E&C
SIET, Tumkur-6



Shridevi Institute of Engineering and Technology,
Tumkur - 572106



DEPARTMENT OF ELECTRICAL & ELECTRONICS ENGINEERING

Date: 31-10-2018

It is here by sending list of students participating in Annual Inter department Cultural activities for the following events

1. Solo Song
2. Group Song
3. Skit
4. Quiz
5. Drama
6. Super Minit
7. Mime
8. MAD ADS

Cultural Coordinator

Head of the Department
Head of the Department
Electrical & Electronics Engineering
Shridevi Institute of Engineering & Technology
TUMKUR-572106.



Shridevi Institute of Engineering and Technology,
Tumkur - 572106



DEPARTMENT OF INFORMATION SCIENCE & ENGINEERING

Date: 01-11-2018

It is here by sending list of students participating in Annual Inter department Cultural activities for the following events

1. Solo Song
2. Group Song
3. Skit
4. Quiz
5. Drama
6. Super Minit
7. Mime
8. MAD ADS

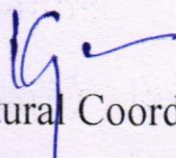
Cultural Coordinator

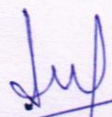
Head of the Department

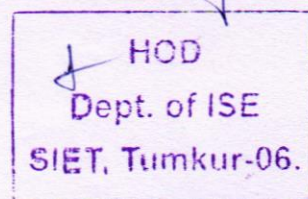



Shridevi Institute of Engineering and Technology,
Tumkur - 572106



DEPARTMENT OF MASTER OF BUSINESS ADMINISTRATION

Date: 31-10-2018

It is here by sending list of students participating in Annual Inter department Cultural activities for the following events

1. Solo Song
2. Group Song
3. Skit
4. Quiz
5. Drama
6. Super Minute
7. Mime
8. MAD ADS

Nadav
Cultural Coordinator

[Signature]
Head of the Department
Head of the Department
M.B.A. Programme
S.J.E.I. Tumkur

**Shridevi Institute of Engineering and Technology,
Tumkur - 572106**





DEPARTMENT OF FIRST YEAR UG STUDIES

Date: 31-10-2018

It is here by sending list of students participating in Annual Inter department Cultural activities for the following events

1. Solo Song
2. Group Song
3. Skit
4. Quiz
5. Drama
6. Super Minit
7. Mime
8. MAD ADS

Cultural Coordinator

Head of the Department

CONSOLIDATED STUDENTS LIST:**SOLO SONG:**

| Sl.No | Name of the Student | USN | Gender | Branch |
|-------|-------------------------|------------|--------|--------|
| 1 | RAGHAVENDRA TEVARI | 1SV18CCS01 | M | CCS |
| 2 | ABDULLAH | 1SV18CS001 | M | CSE |
| 3 | DHARMANA HARIKA | 1SV18CS011 | M | CSE |
| 4 | AKARSH CHANDRAKANTH. | 1SV18CV001 | M | CV |
| 5 | D. T. NAYANA. | 1SV18CV009 | F | CV |
| 6 | ARUN N R | 1SV18EC003 | M | ECE |
| 7 | RAKESH K L | 1SV17EC011 | M | ECE |
| 8 | NETHRANANDA K N | 1SV18EE006 | M | EEE |
| 9 | AJITH KUMAR S | 1SV17EE001 | M | EEE |
| 10 | RACHANA V | 1SV17IS002 | F | IS |
| 11 | GOWTHAMI C | 1SV15IS004 | F | IS |
| 12 | CHETANA K S | 1SV15IS002 | F | IS |

GROUP SONG:

| Sl.No | Name of the Student | USN | Gender | Branch |
|-------|---------------------|------------|--------|--------|
| 1 | NAVYASHREE. S. G. | 1SV18LVS01 | F | LVS |
| 2 | SHASHI KUMAR KM | 1SV17CV019 | M | CV |
| 3 | SHEKHAR MISHRA | 1SV17CV020 | M | CV |
| 4 | NITHIN S D | 1SV15IS010 | M | IS |
| 5 | NIVEDITHA S | 1SV15IS011 | F | IS |
| 6 | ANUSHA G S | 1SV18EC002 | F | ECE |
| 7 | ARUN N R | 1SV18EC003 | M | ECE |
| 8 | ABHISHEK G M | 1SV18EE001 | M | EEE |
| 9 | AMOGHAVARSHA M | 1SV18EE002 | M | EEE |
| 10 | GAVIDIDDAPPA | 1SV18EE003 | M | EEE |

SKIT:

| Sl.No | Name of the Student | USN | Gender | Branch |
|-------|----------------------------------|------------|--------|--------|
| 1 | MURFUA FATHIMA | 1SV18CS026 | F | CSE |
| 2 | M D SHAHID ALI | 1SV18CS027 | M | CSE |
| 3 | ANIL KUMAR B S | 1SV17CV002 | M | CV |
| 4 | BHUMIKA M R | 1SV17CV004 | F | cv |
| 5 | DAVID MALSAWMTLUANGA SAILO | 1SV17CV005 | M | CV |
| 6 | SAGAR R | 1SV15IS014 | M | IS |
| 7 | ROHAN B P | 1SV14CS057 | M | CSE |
| 8 | SHRAVYA P | 1SV15IS015 | F | IS |
| 9 | SUSHANTH A JAIN | 1SV15IS017 | M | IS |
| 10 | ASHA T R | 1SV15CS007 | F | CSE |
| 11 | NUTHANA R | 1SV15IS012 | F | IS |
| 12 | POOJA K | 1SV15IS013 | F | IS |

QUIZ:

| Sl.No | Name of the Student | USN | Gender | Branch |
|-------|---------------------|------------|--------|--------|
| 1 | AMUDHA. | 1SV18MBA01 | F | MBA |
| 2 | ANANTHU. S. M. | 1SV18MBA02 | M | MBA |
| 3 | MANJUSHREE. B. G. | 1SV18MBA15 | F | MBA |
| 4 | MANOHARA. M. R. | 1SV18MBA16 | M | MBA |
| 5 | MANOJ. G. M. | 1SV18CV021 | M | CV |
| 6 | MANU. T. | 1SV18CV022 | M | CV |
| 7 | | | | |
| 8 | MARUTHI PRASAD | 1SV17MBA17 | M | MBA |
| 9 | MUBARAK | 1SV17MBA18 | M | MBA |
| 10 | POORNIMA A S | 1SV17MBA22 | F | MBA |
| 11 | SHAHEEN TAJ C | 1SV17MBA27 | F | MBA |
| 12 | BRUNDA K | 1SV18EC006 | F | ECE |

DRAMA:

| Sl.No | Name of the Student | USN | Gender | Branch |
|-------|---------------------|------------|--------|--------|
| 1 | ROUSHAN ALI KHAN | 1SV18ME009 | M | ME |
| 2 | AMEENA FARHEEN | 1SV15CS003 | F | CSE |
| 3 | ANUSHA A | 1SV15CS004 | F | CSE |
| 4 | TEJASHREE N | 1SV15IS018 | F | IS |
| 5 | VARSHITHA R | 1SV15IS019 | F | IS |
| 6 | HRUTHVIK. P. | 1SV18CV017 | M | CV |
| 7 | DEEPTHI K S | 1SV14IS005 | F | IS |
| 8 | ANIKET ASHOK NEJE | 1SV18EC001 | M | ECE |
| 9 | NAGALAKSHMI. | 1SV18CV023 | F | cv |
| 10 | RAMYA B | 1SV17CV016 | F | cv |
| 11 | SANJANA P O | 1SV17CV017 | F | cv |
| 12 | SATISH C | 1SV17CV018 | M | CV |

SUPER MIN:

| Sl.No | Name of the Student | USN | Gender | Branch |
|-------|--------------------------|------------|--------|--------|
| 1 | SANTHOSHBHARADWAJ H A | 1SV17IS004 | M | IS |
| 2 | GOWTHAMI C | 1SV15IS004 | F | IS |
| 3 | NARASIMHAMURTHY N | 1SV15IS009 | M | IS |
| 4 | REKHA K N | 1SV17EC013 | F | ECE |
| 5 | SAHANA G R | 1SV17EC014 | F | ECE |
| 6 | SHOBHASHREE S | 1SV18EE011 | F | EEE |
| 7 | KEERTANA R | 1SV17EE003 | F | EEE |
| 8 | AKARSH CHANDRAKANTH. | 1SV18CV001 | M | CV |
| 9 | AMRUTAVARSHINI BARKI. | 1SV18CV002 | F | CV |
| 10 | APOORVA. A. | 1SV18CV003 | F | CV |
| 11 | BASAVARAJ | 1SV18EC004 | M | ECE |

MIME:

| Sl.No | Name of the Student | USN | Gender | Branch |
|-------|---------------------|------------|--------|--------|
| 1 | ENCHARA M | 1SV18CS014 | F | CSE |
| 2 | SHUAIB AHMED | 1SV17CV021 | M | CV |
| 3 | RAJU ND | 1SV17CV014 | M | CV |
| 4 | ANIL GOWDA | 1SV17CS005 | M | CSE |
| 5 | NITHIN KUMAR B N | 1SV17IS001 | M | IS |
| 6 | RACHANA V | 1SV17IS002 | F | IS |
| 7 | RAKIYA UZMA | 1SV17IS003 | F | IS |
| 8 | BASAVARAJ | 1SV18EC004 | M | ECE |
| 9 | BHARATHI M | 1SV18EC005 | F | ECE |
| 10 | RAKESH S | 1SV17CV015 | M | CV |
| 11 | NETHRAVATHI SM | 1SV17EE006 | F | EEE |
| 12 | RAMYA B | 1SV17CV016 | F | CV |

MAD ADS:

| Sl.No | Name of the Student | USN | Gender | Branch |
|-------|----------------------------------|------------|--------|--------|
| 1 | AKARSH CHANDRAKANTH. | 1SV18CV001 | M | CV |
| 2 | ROUSHAN ALI KHAN | 1SV18ME009 | M | ME |
| 3 | BHARATH N M | 1SV18ME002 | M | ME |
| 4 | PRAKASH M | 1SV17ME009 | M | ME |
| 5 | SHIVAGOUD KUMATHALLI | 1SV17ME011 | M | ME |
| 6 | SHIVARAJ MULLOLLI | 1SV17ME012 | M | ME |
| 7 | RAKESH K L | 1SV17EC011 | M | ECE |
| 8 | R. LAKSHMI. K. RAMACHANDRAPPA | 1SV18SCS01 | F | SCS |
| 9 | JAYANTH. C. | 1SV18MMD01 | M | MMD |
| 10 | RAVI K N | 1SV17MMD01 | M | MMD |
| 11 | DEEPIKA H V | 1SV17SCS01 | F | SCS |
| 12 | ARUN N R | 1SV18EC003 | M | ECE |

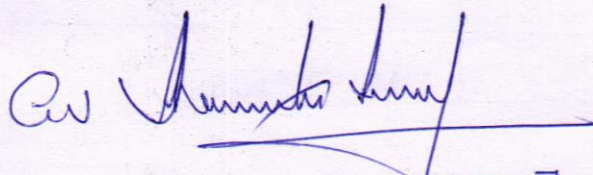
[CULTURAL COORDINATOR]

PRINCIPAL
SHRIDEVI INSTITUTE OF
ENGINEERING AND TECHNOLOGY
TUMKUR - 572106

SNAPSHOT OF ANNUAL INTER DEPARTMENTAL CULTURAL ACTIVITIES



STUDENT PARTICIPATING IN SUPER MINUTE



STUDENT PARTICIPATING IN GROUP SONG

**Shridevi Institute of Engineering and Technology,
Tumkur - 572106**

Date: 03/11/2018

WINNER LIST

| Sl.No. | NAME OF THE EVENT | EVENT WINNERS | |
|--------|-------------------|---------------------------------------|----------------------------------|
| | | 1 st Place | 2 nd Place |
| 1 | Solo Song | DHARMANA HARIKA (1SV18CS011) | ARUN N R (1SV18EC003) |
| 2 | Group Song | ABHISHEK G M(1SV18EE001) & TEAM | NITHIN S D(1SV15IS010) & TEAM |
| 3 | Skit | BHUMIKA M R(1SV17CV004) & TEAM | NUTHANA R(1SV15IS012) & TEAM |
| 4 | Quiz | MARUTHI PRASAD 1SV17MBA17 | MUBARAK 1SV17MBA18 |
| 5 | Drama | HRUTHVIK. P(1SV18CV017) & TEAM | SATISH C(1SV17CV018) & TEAM |
| 6 | Mime | NETHRAVATHI SM (1SV17EE006) & TEAM | ENCHARA M(1SV18CS014) & TEAM |
| 7 | MAD ADS | JAYANTH. C (1SV18MMD01) & TEAM | PRAKASH M(1SV17ME009) & TEAM |



(Prof. Aijaz Ahamed Sharief)

Cultural Coordinator



(Dr. Hemadri Naidu.T)

PRINCIPAL
SHRIDEVI INSTITUTE OF
ENGINEERING AND TECHNOLOGY
TUMKUR - 572106



Phone: 0816-2212629 | Fax: 0816-2212628 | Email: info@shrideviengineering.org | Web: http://www.shrideviengineering.org

Sri Shridevi Charitable Trust (R.)
SHRIDEVI INSTITUTE OF ENGINEERING & TECHNOLOGY
(Recognised by Govt. of Karnataka, Affiliated to VTU, Belagavi and Approved by AICTE, New Delhi)
Sira Road, Tumakuru - 572 106. Karnataka.



An ISO 9001:2015 Certified Institution

ANNUAL INTER DEPARTMENT CULTURAL COMPETITIONS

CERTIFICATE

This is to certify that Mr. / Ms. ABHISHEK G M of

1SV18EE001 has secured the 1st Place in

GROUP SONG at the Annual Inter Department

Cultural Competitions in the Academic year 2018-19.

Prof. AIJAZ AHAMED SHARIEF
Cultural Coordinator

Dr. HEMADRI NAIDU. T
Principal, SIET



Sri Shridevi Charitable Trust (R.)
SHRIDEVI INSTITUTE OF ENGINEERING & TECHNOLOGY

(Recognised by Govt. of Karnataka, Affiliated to VTU, Belagavi and Approved by AICTE, New Delhi)

Sira Road, Tumakuru - 572 106. Karnataka.

Phone: 0816-2212629 | Fax: 0816-2212628 | Email: info@shrideviengineering.org | Web: http://www.shrideviengineering.org



An ISO 9001:2015 Certified Institution

ANNUAL INTER DEPARTMENT CULTURAL COMPETITIONS

CERTIFICATE

This is to certify that Mr. / Ms. ARUN N R of

1SV18EC003 has secured the 2nd Place in

SOLO SONG at the Annual Inter Department

Cultural Competitions in the Academic year 2018-19.

Prof. AIJAZ AHAMED SHARIEF
Cultural Coordinator

Dr. HEMADRI NAIDU. T
Principal, SIET



Sri Shridevi Charitable Trust (R.)

SHRIDEVI INSTITUTE OF ENGINEERING & TECHNOLOGY

Sira Road, Tumkur - 572 106, Karnataka, India.

Phone: 0816 - 2212629 | Principal: 0816 - 2212627, 9686114899 | Telefax: 0816 - 2212628

Email: info@shrideviengineering.org, principal@shrideviengineering.org | Website: www.shrideviengineering.org

(Approved by AICTE, New Delhi, Recognised by Govt. of Karnataka and Affiliated to Visvesvaraya Technological University, Belagavi)

ESTD: 2002



ANNUAL INTER DEPARTMENTAL SPORTS ACTIVITIES

2018-19



**Shridevi Institute of Engineering and Technology,
Tumkur - 572106**

Ref: SIET/Office/2018-19/

Date: 21-11-2018

CIRCULAR

It is here by informed to all the Sports Co-ordinators (from each dept) and student sports Co-ordinators, both boys and girls have to attend the meeting in the eve of Sports activities for the Academic year 2018-19. I request all to assemble in Dept of physical education at 10-00 Am on 22-11-2018 Wednesday without fail.

(Mr.Raghavendra Jattendra)

PED SIET
Physical Education Director.
Dept. of Physical Education,
Shridevi Institute of Engineering & Technology
Sira Road, Tumkur-572106

(Dr. Hemadri Naidu.T)

PRINCIPAL
SHRIDEVI INSTITUTE OF
ENGINEERING AND TECHNOLOGY
TUMKUR - 572106.

Copy to HODs: BT/CS/EC/EE/ME/IS/CIVIL/MBA/ Academic coordinator / Office

**Shridevi Institute of Engineering and Technology,
Tumkur - 572106**

Ref: SIET/SPORTS/2018-19

Date: 27-11-2018

CIRCULAR

It is here by informed to all the Department HODs Staffs Sports Co-ordinators & student sports Co-ordinators, Sports activities Schedule on .

| | | | |
|---------------------|-------------|------------|----------|
| 1. Throw Ball | : Monday | 03-12-2018 | 11.30 AM |
| 2. Volley Ball | : Tuesday | 04-12-2018 | 2.30 PM |
| 3. Kho Kho | : Thursday | 06-12-2018 | 2.30 PM |
| 4. Cricket | : Friday | 07-12-2018 | 2.30 PM |
| 5. Ball Badminton | : Monday | 10-12-2018 | 2.30 PM |
| 6. Kabaddi | : Monday | 10-12-2018 | 2.30 PM |
| 7. Shatal Badminton | : Tuesday | 11-12-2018 | 2.30 PM |
| 8. Basketball | : Wednesday | 12-12-2018 | 2.30 PM |
| 9. Carom | : Thursday | 13-12-2018 | 2.30 PM |
| 10. Chess | : Thursday | 13-12-2018 | 2.30 PM |
| 11. Table Tennis | : Friday | 14-12-2018 | 2.30 PM |
| 12. Gim | : Saturday | 15-12-2018 | 10.30 AM |
| 13. Hand ball | : Monday | 17-12-2018 | 11.30 AM |
| 14. Foot Ball | : Tuesday | 18-12-2018 | 2.30 PM |

Copy to HODs: CS/EC/EE/ME/IS/CIVIL/MBA/First Year/ Academic coordinator/Office/ Shri Utsav Co-ordinator



(Mr.Raghavendra Jattendra)

PED SIET

(9880984474)

Physical Education Director,

Dept. of Physical Education,

Shridevi Institute of Engineering & Technology

Sira Road, Tumkur-572106

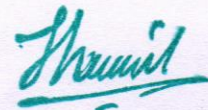

PRINCIPAL
SIET, TUMKUR

(Dr. Hemadri Naidu.T)

PRINCIPAL

SHRIDEVI INSTITUTE OF
ENGINEERING AND TECHNOLOGY
TUMKUR - 572106



DEPARTMENT OF MECHANICAL ENGINEERING

Date: 29-11-2018

It is here by sending list of students participating in Annual Inter department sports activities for the following events

- | | | | |
|---------------------|-------------|------------|----------|
| 1. Throw Ball | : Monday | 03-12-2018 | 11.30 AM |
| 2. Volley Ball | : Tuesday | 04-12-2018 | 2.30 PM |
| 3. Kho Kho | : Thursday | 06-12-2018 | 2.30 PM |
| 4. Cricket | : Friday | 07-12-2018 | 2.30 PM |
| 5. Ball Badminton | : Monday | 10-12-2018 | 2.30 PM |
| 6. Kabaddi | : Monday | 10-12-2018 | 2.30 PM |
| 7. Shatal Badminton | : Tuesday | 11-12-2018 | 2.30 PM |
| 8. Basketball | : Wednesday | 12-12-2018 | 2.30 PM |
| 9. Carom | : Thursday | 13-12-2018 | 2.30 PM |
| 10. Chess | : Thursday | 13-12-2018 | 2.30 PM |
| 11. Table Tennis | : Friday | 14-12-2018 | 2.30 PM |
| 12. Gim | : Saturday | 15-12-2018 | 10.30 AM |
| 13. Hand ball | : Monday | 17-12-2018 | 11.30 AM |
| 14. Foot Ball | : Tuesday | 18-12-2018 | 2.30 PM |

Sports Coordinator

Head of the Department
H.O.D
Dept. of Mechanical
S.I.E.T., TUMKUR -6

**LIST OF STUDENTS PARTICIPATING IN ANNUAL INTERDEPARTMENTAL
ANNUAL SPORTS ACTIVITY 2018-19**

| ME | | | | | |
|------------|------------|---------------------|--------|----------|--------|
| THROW BALL | | | | | |
| SLNO | USN | NAME OF THE STUDENT | GENDER | YEAR | BRANCH |
| 1 | 1SV15ME061 | SAGAR K | M | II YEAR | ME |
| 2 | 1SV17ME001 | ABHISHEK KUMBAR | M | II YEAR | ME |
| 3 | 1SV17ME003 | GURURAJA M R | M | II YEAR | ME |
| 4 | 1SV17ME004 | KALLES H D | M | II YEAR | ME |
| 5 | 1SV17ME006 | MD NAUSHAD | M | II YEAR | ME |
| 6 | 1SV17ME007 | MOHD GUFRAN | M | II YEAR | ME |
| 7 | 1SV16ME415 | PRATHAP R N | M | III YEAR | ME |
| 8 | 1SV14ME011 | BHARATH KALMANE G | M | IV YEAR | ME |
| 9 | 1SV14ME016 | CHETHAN G S | M | IV YEAR | ME |
| 10 | 1SV14ME050 | MARUTHI K R | M | IV YEAR | ME |
| 11 | 1SV15ME419 | RAKSHITH S | M | IV YEAR | ME |
| 12 | 1SV15ME420 | RAMAKRISHNA G D | M | IV YEAR | ME |

| VOLLEY BALL | | | | | |
|-------------|------------|------------------------|--------|----------|--------|
| SLNO | USN | NAME OF THE STUDENT | GENDER | YEAR | BRANCH |
| 1 | 1SV16ME412 | PRAVEEN P | M | IV YEAR | ME |
| 2 | 1SV16ME413 | PAVAN K S | M | IV YEAR | ME |
| 3 | 1SV17ME011 | SHIVAGOUD KUMATHALLI | M | II YEAR | ME |
| 4 | 1SV17ME012 | SHIVARAJ MULLOLLI | M | II YEAR | ME |
| 5 | 1SV17ME013 | SHRINATH JADHAV | M | II YEAR | ME |
| 6 | 1SV15ME077 | SRIDHAR N J | M | IV YEAR | ME |
| 7 | 1SV15ME079 | TIRUPATI MOTEPPA RATHO | M | IV YEAR | ME |
| 8 | 1SV14ME069 | RAMESH S | M | III YEAR | ME |
| 9 | 1SV14ME073 | SAGAR J | M | III YEAR | ME |
| 10 | 1SV14ME006 | AKSHAY A | M | III YEAR | ME |
| 11 | 1SV14ME028 | GURUSIDDAIAH A R | M | III YEAR | ME |
| 12 | 1SV14ME011 | BHARATH KALMANE G | M | IV YEAR | ME |

| KHO KHO | | | | | |
|---------|------------|------------------------------------|--------|----------|--------|
| SLNO | USN | NAME OF THE STUDENT | GENDER | YEAR | BRANCH |
| 1 | 1SV15ME019 | HARISH KUMAR K T | M | IV YEAR | ME |
| 2 | 1SV15ME023 | KARTHIK G K | M | IV YEAR | ME |
| 3 | 1SV15ME037 | MARUTI DODMANI | M | III YEAR | ME |
| 4 | 1SV15ME038 | MD ARSHAD ASHFAQUE | M | III YEAR | ME |
| 5 | 1SV15ME052 | PRAVEEN KUMAR G N | M | III YEAR | ME |
| 6 | 1SV14ME088 | VIJAYAKUMAR KALLAPPAGOUDA PATIL | M | III YEAR | ME |
| 7 | 1SV15ME006 | AMARNATH M | M | III YEAR | ME |
| 8 | 1SV18ME402 | KARTHIK Y N | M | II YEAR | ME |
| 9 | 1SV18ME403 | MUHAMMED SHUMAZ SHARIER | M | II YEAR | ME |
| 10 | 1SV18ME404 | NAVEENKUMARA | M | II YEAR | ME |
| 11 | 1SV18ME406 | RAVINDRANATHA K | M | II YEAR | ME |
| 12 | 1SV17ME001 | ABHISHEK KUMBAR | M | II YEAR | ME |

| CRICKET | | | | | |
|---------|------------|---------------------|--------|----------|--------|
| SLNO | USN | NAME OF THE STUDENT | GENDER | YEAR | BRANCH |
| 1 | 1SV18ME408 | SRIKANTH K S | M | II YEAR | ME |
| 2 | 1SV15ME088 | TANVEER KHAN | M | II YEAR | ME |
| 3 | 1SV14ME006 | AKSHAY A | M | III YEAR | ME |
| 4 | 1SV14ME028 | GURUSIDDAIAH A R | M | III YEAR | ME |
| 5 | 1SV14ME030 | HARISHBABU M | M | III YEAR | ME |
| 6 | 1SV14ME026 | GIRISH B V | M | IV YEAR | ME |
| 7 | 1SV14ME034 | JAGADEESH | M | IV YEAR | ME |
| 8 | 1SV14ME055 | MURULI N | M | IV YEAR | ME |
| 9 | 1SV14ME064 | PRAJWAL C R | M | IV YEAR | ME |
| 10 | 1SV14ME083 | SUNILAKUMAR | M | IV YEAR | ME |
| 11 | 1SV14ME084 | SWAMY R T | M | IV YEAR | ME |
| 12 | 1SV15ME001 | ABHILASH V | M | IV YEAR | ME |
| 13 | 1SV14ME050 | MARUTHI K R | M | IV YEAR | ME |
| 14 | 1SV15ME419 | RAKSHITH S | M | IV YEAR | ME |
| 15 | 1SV17ME013 | SHRINATH JADHAV | M | II YEAR | ME |

| BALL BADMINTON | | | | | |
|----------------|------------|--------------------------|--------|----------|--------|
| SLNO | USN | NAME OF THE STUDENT | GENDER | YEAR | BRANCH |
| 1 | 1SV17ME004 | KALLES H D | M | II YEAR | ME |
| 2 | 1SV17ME006 | MD NAUSHAD | M | II YEAR | ME |
| 3 | 1SV15ME013 | HARISH D R | M | III YEAR | ME |
| 4 | 1SV15ME014 | DEEPAK R | M | III YEAR | ME |
| 5 | 1SV14ME011 | BHARATH KALMANE G | M | IV YEAR | ME |
| 6 | 1SV14ME016 | CHETHAN G S | M | IV YEAR | ME |
| 7 | 1SV15ME048 | PIDAPPA JEEVAN KISHORE R | M | IV YEAR | ME |
| 8 | 1SV15ME049 | PRADEEP P S | M | IV YEAR | ME |
| 9 | 1SV15ME051 | PRAVEEN F KAMADOLLI | M | IV YEAR | ME |
| 10 | 1SV12ME019 | ARUN MATHEW | M | IV YEAR | ME |

| KABADDI | | | | | |
|---------|------------|-------------------------------|--------|----------|--------|
| SLNO | USN | NAME OF THE STUDENT | GENDER | YEAR | BRANCH |
| 1 | 1SV15ME079 | TIRUPATI MOTEPPA RATHO | M | IV YEAR | ME |
| 2 | 1SV15ME083 | VINOD T H | M | IV YEAR | ME |
| 3 | 1SV16ME400 | ANANDKUMAR D | M | IV YEAR | ME |
| 4 | 1SV16ME402 | CHETAN M PATIL | M | IV YEAR | ME |
| 5 | 1SV16ME403 | HARISH J | M | IV YEAR | ME |
| 6 | 1SV16ME404 | HARISHA L | M | IV YEAR | ME |
| 7 | 1SV15ME052 | PRAVEEN KUMAR G N | M | III YEAR | ME |
| 8 | 1SV15ME060 | SACHIN CHANDRAKANT BIRADAR | M | III YEAR | ME |
| 9 | 1SV17ME013 | SHRINATH JADHAV | M | II YEAR | ME |
| 10 | 1SV18ME400 | BHANUPRAKASH | M | II YEAR | ME |
| 11 | 1SV17ME008 | PAVAN M S | M | II YEAR | ME |
| 12 | 1SV14ME047 | MANOJ KUMAR V N | M | III YEAR | ME |

| SHATAL BADMINTON | | | | | |
|------------------|------------|-----------------------|--------|--------|--------|
| SLNO | USN | NAME OF THE STUDENT | GENDER | YEAR | BRANCH |
| 1 | 1SV18EE013 | VISHAL D SOUZA | M | I YEAR | EEE |
| 2 | 1SV18ME009 | ROUSHAN ALI KHAN | M | I YEAR | ME |
| 3 | 1SV18CS047 | YASHVANTHKUMAR P | M | I YEAR | CSE |
| 4 | 1SV18CV032 | SHIVA SHANKARA. C. S. | M | I YEAR | CV |
| 5 | 1SV18EC012 | MOUNESHGOWDA | M | I YEAR | ECE |

| BASKET BALL | | | | | |
|-------------|------------|------------------------|--------|----------|--------|
| SLNO | USN | NAME OF THE STUDENT | GENDER | YEAR | BRANCH |
| 1 | 1SV15ME077 | SRIDHAR N J | M | IV YEAR | ME |
| 2 | 1SV15ME079 | TIRUPATI MOTEPPA RATHO | M | IV YEAR | ME |
| 3 | 1SV16ME411 | NITHIN KUMAR J N | M | III YEAR | ME |
| 4 | 1SV16ME415 | PRATHAP R N | M | III YEAR | ME |
| 5 | 1SV14ME011 | BHARATH KALMANE G | M | IV YEAR | ME |
| 6 | 1SV14ME016 | CHETHAN G S | M | IV YEAR | ME |
| 7 | 1SV18ME407 | SAGAR R | M | II YEAR | ME |
| 8 | 1SV18ME408 | SRIKANTH K S | M | II YEAR | ME |
| 9 | 1SV15ME088 | TANVEER KHAN | M | II YEAR | ME |
| 10 | 1SV14ME006 | AKSHAY A | M | III YEAR | ME |

| CAROM | | | | | |
|-------|------------|---------------------|--------|---------|--------|
| SLNO | USN | NAME OF THE STUDENT | GENDER | YEAR | BRANCH |
| 1 | 1SV17ME014 | UMESH R | M | II YEAR | ME |
| 2 | 1SV15ME032 | MANJUNATHAREDDY K P | M | IV YEAR | ME |

| CHESS | | | | | |
|-------|------------|---------------------|--------|----------|--------|
| SLNO | USN | NAME OF THE STUDENT | GENDER | YEAR | BRANCH |
| 1 | 1SV15ME013 | HARISH D R | M | III YEAR | ME |
| 2 | 1SV15ME088 | TANVEER KHAN | M | II YEAR | ME |

| TABLE TENNIS | | | | | |
|--------------|------------|------------------------|--------|---------|--------|
| SLNO | USN | NAME OF THE STUDENT | GENDER | YEAR | BRANCH |
| 1 | 1SV17ME011 | SHIVAGOUD KUMATHALLI | M | II YEAR | ME |
| 2 | 1SV15ME079 | TIRUPATI MOTEPPA RATHO | M | IV YEAR | ME |

| THROW BALL | | | | | |
|------------|------------|----------------------|--------|---------|--------|
| SLNO | USN | NAME OF THE STUDENT | GENDER | YEAR | BRANCH |
| 1 | 1SV15ME012 | CHANDANA S M | F | II YEAR | ME |
| 2 | 1SV18ME405 | PRABHAVATHI B R | F | II YEAR | ME |
| 3 | 1SV15ME007 | AMRUTHA M | F | IV YEAR | ME |
| 4 | 1SV15ME025 | KOMALA C M | F | IV YEAR | ME |
| 5 | 1SV15ME062 | SAHANA | F | IV YEAR | ME |
| 6 | 1SV15ME074 | SINDHU K N | F | IV YEAR | ME |
| 7 | 1SV15ME075 | SNEHA T N | F | IV YEAR | ME |
| 8 | 1SV13ME027 | DIVAKARA ARADHYA H B | F | IV YEAR | ME |

| KHO KHO | | | | | |
|---------|------------|----------------------|--------|---------|--------|
| SLNO | USN | NAME OF THE STUDENT | GENDER | YEAR | BRANCH |
| 1 | 1SV15ME012 | CHANDANA S M | F | II YEAR | ME |
| 2 | 1SV18ME405 | PRABHAVATHI B R | F | II YEAR | ME |
| 3 | 1SV15ME007 | AMRUTHA M | F | IV YEAR | ME |
| 4 | 1SV15ME025 | KOMALA C M | F | IV YEAR | ME |
| 5 | 1SV15ME062 | SAHANA | F | IV YEAR | ME |
| 6 | 1SV15ME074 | SINDHU K N | F | IV YEAR | ME |
| 7 | 1SV15ME075 | SNEHA T N | F | IV YEAR | ME |
| 8 | 1SV13ME027 | DIVAKARA ARADHYA H B | F | IV YEAR | ME |

| BALL BADMINTON | | | | | |
|----------------|------------|----------------------|--------|---------|--------|
| SLNO | USN | NAME OF THE STUDENT | GENDER | YEAR | BRANCH |
| 1 | 1SV15ME012 | CHANDANA S M | F | II YEAR | ME |
| 2 | 1SV18ME405 | PRABHAVATHI B R | F | II YEAR | ME |
| 3 | 1SV15ME007 | AMRUTHA M | F | IV YEAR | ME |
| 4 | 1SV15ME025 | KOMALA C M | F | IV YEAR | ME |
| 5 | 1SV15ME062 | SAHANA | F | IV YEAR | ME |
| 6 | 1SV15ME074 | SINDHU K N | F | IV YEAR | ME |
| 7 | 1SV15ME075 | SNEHA T N | F | IV YEAR | ME |
| 8 | 1SV13ME027 | DIVAKARA ARADHYA H B | F | IV YEAR | ME |

| SHATAL BADMINTON | | | | | |
|------------------|------------|----------------------|--------|---------|--------|
| SLNO | USN | NAME OF THE STUDENT | GENDER | YEAR | BRANCH |
| 1 | 1SV15ME062 | SAHANA | F | IV YEAR | ME |
| 2 | 1SV15ME074 | SINDHU K N | F | IV YEAR | ME |
| 3 | 1SV15ME075 | SNEHA T N | F | IV YEAR | ME |
| 4 | 1SV13ME027 | DIVAKARA ARADHYA H B | F | IV YEAR | ME |
| 5 | 1SV18ME405 | PRABHAVATHI B R | F | II YEAR | ME |

| CAROM | | | | | |
|-------|------------|---------------------|--------|---------|--------|
| SLNO | USN | NAME OF THE STUDENT | GENDER | YEAR | BRANCH |
| 1 | 1SV18ME405 | PRABHAVATHI B R | F | II YEAR | ME |
| 2 | 1SV15ME007 | AMRUTHA M | F | IV YEAR | ME |

| CHESS | | | | | |
|-------|------------|---------------------|--------|---------|--------|
| SLNO | USN | NAME OF THE STUDENT | GENDER | YEAR | BRANCH |
| 1 | 1SV15ME062 | SAHANA | F | IV YEAR | ME |
| 2 | 1SV18ME405 | PRABHAVATHI B R | F | II YEAR | ME |

| TABLE TENNIS | | | | | |
|--------------|------------|----------------------|--------|---------|--------|
| SLNO | USN | NAME OF THE STUDENT | GENDER | YEAR | BRANCH |
| 1 | 1SV15ME075 | SNEHA T N | F | IV YEAR | ME |
| 2 | 1SV13ME027 | DIVAKARA ARADHYA H B | F | IV YEAR | ME |

| HAND BALL | | | | | |
|-----------|------------|---------------------|--------|----------|--------|
| SLNO | USN | NAME OF THE STUDENT | GENDER | YEAR | BRANCH |
| 1 | 1SV14ME006 | AKSHAY A | M | III YEAR | ME |
| 2 | 1SV14ME028 | GURUSIDDAIAH A R | M | III YEAR | ME |
| 3 | 1SV14ME030 | HARISHBABU M | M | III YEAR | ME |
| 4 | 1SV14ME038 | KANHAIYA LAL SAHANI | M | III YEAR | ME |
| 5 | 1SV14ME047 | MANOJ KUMAR V N | M | III YEAR | ME |
| 6 | 1SV17ME007 | MOHD GUFRAN | M | II YEAR | ME |
| 7 | 1SV17ME001 | ABHISHEK KUMBAR | M | II YEAR | ME |
| 8 | 1SV17ME003 | GURURAJA M R | M | II YEAR | ME |
| 9 | 1SV15ME010 | AVINASH N | M | IV YEAR | ME |
| 10 | 1SV15ME017 | GOVINDARAJU B N | M | IV YEAR | ME |
| 11 | 1SV15ME018 | HANUMESH NAYAKAR | M | IV YEAR | ME |

| FOOT BALL | | | | | |
|-----------|------------|---------------------|--------|----------|--------|
| SLNO | USN | NAME OF THE STUDENT | GENDER | YEAR | BRANCH |
| 1 | 1SV16ME409 | MANU K B | M | IV YEAR | ME |
| 2 | 1SV16ME410 | MARUTHI K R | M | IV YEAR | ME |
| 3 | 1SV16ME412 | PRAVEEN P | M | IV YEAR | ME |
| 4 | 1SV16ME413 | PAVAN K S | M | IV YEAR | ME |
| 5 | 1SV17ME004 | KALLESH H D | M | II YEAR | ME |
| 6 | 1SV16ME417 | RAGHAVENDRA B S | M | IV YEAR | ME |
| 7 | 1SV16ME418 | RAGHAVENDRA K | M | IV YEAR | ME |
| 8 | 1SV16ME419 | RAGHAVENDRA MAHADEV | M | IV YEAR | ME |
| 9 | 1SV15ME086 | YOGESH B V | M | III YEAR | ME |
| 10 | 1SV16ME406 | KHALEELULLA | M | III YEAR | ME |
| 11 | 1SV16ME411 | NITHIN KUMAR J N | M | III YEAR | ME |
| 12 | 1SV16ME415 | PRATHAP R N | M | III YEAR | ME |
| 13 | 1SV14ME011 | BHARATH KALMANE G | M | IV YEAR | ME |
| 14 | 1SV14ME016 | CHETHAN G S | M | IV YEAR | ME |
| 15 | 1SV14ME018 | CHETHAN KUMAR C B | M | IV YEAR | ME |
| 16 | 1SV18ME400 | BHANUPRAKASH | M | II YEAR | ME |

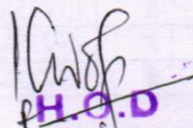
 P.H.O.D
 Dept. of Mechanical
 S.I.E.T., TUMKUR - 6

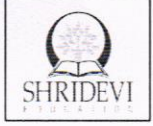

Shridevi Institute of Engineering and Technology,
Tumkur - 572106



DEPARTMENT OF CIVIL ENGINEERING

Date:30-11-2018

It is here by sending list of students participating in Annual Inter department sports activities for the following events

- | | | | |
|---------------------|-------------|------------|----------|
| 1. Throw Ball | : Monday | 03-12-2018 | 11.30 AM |
| 2. Volley Ball | : Tuesday | 04-12-2018 | 2.30 PM |
| 3. Kho Kho | : Thursday | 06-12-2018 | 2.30 PM |
| 4. Cricket | : Friday | 07-12-2018 | 2.30 PM |
| 5. Ball Badminton | : Monday | 10-12-2018 | 2.30 PM |
| 6. Kabaddi | : Monday | 10-12-2018 | 2.30 PM |
| 7. Shatal Badminton | : Tuesday | 11-12-2018 | 2.30 PM |
| 8. Basketball | : Wednesday | 12-12-2018 | 2.30 PM |
| 9. Carom | : Thursday | 13-12-2018 | 2.30 PM |
| 10. Chess | : Thursday | 13-12-2018 | 2.30 PM |
| 11. Table Tennis | : Friday | 14-12-2018 | 2.30 PM |
| 12. Gim | : Saturday | 15-12-2018 | 10.30 AM |
| 13. Hand ball | : Monday | 17-12-2018 | 11.30 AM |
| 14. Foot Ball | : Tuesday | 18-12-2018 | 2.30 PM |

Sports Coordinator

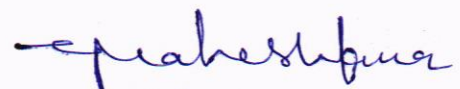
Head of the Department
HOD
Dept. of Civil Engineering
SIET, TUMKUR - 6.

LIST OF STUDENTS PARTICIPATING IN ANNUAL INTERDEPARTMENTAL
ANNUAL SPORTS ACTIVITY 2018-19

THROW BALL

| SLNO | USN | NAME OF THE STUDENT | GENDER | YEAR | BRANCH |
|------|------------|-------------------------------|--------|----------|--------|
| 1 | 1SV17CV002 | ANIL KUMAR B S | M | II YEAR | CV |
| 2 | 1SV17CV005 | DAVID MALSAWMTLUANGA SAILO | M | II YEAR | CV |
| 3 | 1SV17CV006 | GAGANDEEP KS | M | II YEAR | CV |
| 4 | 1SV17CV007 | HRUTHIK ROHAN N J | M | II YEAR | CV |
| 5 | 1SV17CV008 | JAYAMANJUSH CHOUDRI | M | II YEAR | CV |
| 6 | 1SV17CV010 | LOKESH D | M | II YEAR | CV |
| 7 | 1SV17CV011 | NAJRUL HASAN | M | II YEAR | CV |
| 8 | 1SV17CV013 | PUNITHKUMAR K B | M | II YEAR | CV |
| 9 | 1SV15CV046 | RAKSHITH R D | M | III YEAR | CV |
| 10 | 1SV15CV054 | SOMANAGOUDA BIRADAR | M | III YEAR | CV |
| 11 | 1SV14CV046 | VENKATESH N | M | IV YEAR | CV |
| 12 | 1SV15CV001 | AJAY KUMAR R | M | IV YEAR | CV |

VOLLEY BALL

| SLNO | USN | NAME OF THE STUDENT | GENDER | YEAR | BRANCH |
|------|------------|-----------------------|--------|----------|--------|
| 1 | 1SV17CV026 | RAVI TEJU M | M | II YEAR | CV |
| 2 | 1SV15CV006 | AURANGZEB ALAM ANSARI | M | III YEAR | CV |
| 3 | 1SV15CV007 | AZIMULLA KHAN D | M | III YEAR | CV |
| 4 | 1SV15CV015 | GANESH S D | M | III YEAR | CV |
| 5 | 1SV15CV045 | RAKSHITH J | M | III YEAR | CV |
| 6 | 1SV15CV046 | RAKSHITH R D | M | III YEAR | CV |
| 7 | 1SV15CV054 | SOMANAGOUDA BIRADAR | M | III YEAR | CV |
| 8 | 1SV14CV046 | VENKATESH N | M | IV YEAR | CV |
| 9 | 1SV15CV001 | AJAY KUMAR R | M | IV YEAR | CV |
| 10 | 1SV17CV020 | SHEKHAR MISHRA | M | II YEAR | CV |
| 11 | 1SV17CV021 | SHUAIB AHMED | M | II YEAR | CV |
| 12 | 1SV17CV023 | UDAY KUMAR GOWDA R V | M | II YEAR | CV |

KHO KHO

| SLNO | USN | NAME OF THE STUDENT | GENDER | YEAR | BRANCH |
|------|------------|--------------------------|--------|----------|--------|
| 1 | 1SV15CV009 | BIKRAM KHATRI | M | IV YEAR | CV |
| 2 | 1SV17CV013 | PUNITHKUMAR K B | M | II YEAR | CV |
| 3 | 1SV15CV012 | CHETHAN KUMAR NH | M | IV YEAR | CV |
| 4 | 1SV15CV013 | DHANUSH H M | M | IV YEAR | CV |
| 5 | 1SV17CV027 | NAWAZ KHAN KN | M | II YEAR | CV |
| 6 | 1SV17CV026 | RAVI TEJU M | M | II YEAR | CV |
| 7 | 1SV15CV006 | AURANGZEB ALAM ANSARI | M | III YEAR | CV |
| 8 | 1SV13CV013 | GEZIT BOY KARAM | M | IV YEAR | CV |
| 9 | 1SV12CV002 | AKSHAY C J | M | IV YEAR | CV |
| 10 | 1SV12CV035 | RAGHAVENDRA A | M | IV YEAR | CV |
| 11 | 1SV13CV023 | KENTO LOYA | M | IV YEAR | CV |
| 12 | 1SV13CV035 | MOIRANGTHEM HEMJIT SINGH | M | IV YEAR | CV |

CRICKET

| SLNO | USN | NAME OF THE STUDENT | GENDER | YEAR | BRANCH |
|------|------------|-----------------------|--------|----------|--------|
| 1 | 1SV17CV023 | UDAY KUMAR GOWDA R V | M | II YEAR | CV |
| 2 | 1SV18CV400 | AJITH KUMAR B N | M | II YEAR | CV |
| 3 | 1SV18CV407 | KIRAN P MURAL | M | II YEAR | CV |
| 4 | 1SV18CV411 | NITHIN G Y | M | II YEAR | CV |
| 5 | 1SV15CV046 | RAKSHITH R D | M | III YEAR | CV |
| 6 | 1SV15CV054 | SOMANAGOUDA BIRADAR | M | III YEAR | CV |
| 7 | 1SV14CV046 | VENKATESH N | M | IV YEAR | CV |
| 8 | 1SV15CV034 | MAHANTHESH H S | M | IV YEAR | CV |
| 9 | 1SV15CV036 | MANISH CHAUDHARY | M | IV YEAR | CV |
| 10 | 1SV15CV039 | NIRAJ KUMAR CHAUDHARY | M | IV YEAR | CV |
| 11 | 1SV15CV043 | RAJU RIJAL | M | IV YEAR | CV |

| | | | | | |
|----|------------|---------------|---|---------|----|
| 12 | 1SV12CV035 | RAGHAVENDRA A | M | IV YEAR | CV |
| 13 | 1SV13CV023 | KENTO LOYA | M | IV YEAR | CV |
| 14 | 1SV17CV010 | LOKESH D | M | II YEAR | CV |
| 15 | 1SV17CV011 | NAJRUL HASAN | M | II YEAR | CV |

BALL BADMINTON

| SLNO | USN | NAME OF THE STUDENT | GENDER | YEAR | BRANCH |
|------|------------|-------------------------------|--------|----------|--------|
| 1 | 1SV17CV002 | ANIL KUMAR B S | M | II YEAR | CV |
| 2 | 1SV17CV005 | DAVID MALSAWMTLUANGA SAILO | M | II YEAR | CV |
| 3 | 1SV17CV027 | NAWAZ KHAN KN | M | II YEAR | CV |
| 4 | 1SV17CV026 | RAVI TEJU M | M | II YEAR | CV |
| 5 | 1SV15CV054 | SOMANAGOUDA BIRADAR | M | III YEAR | CV |
| 6 | 1SV14CV046 | VENKATESH N | M | IV YEAR | CV |
| 7 | 1SV16CV403 | PAVAN O | M | IV YEAR | CV |
| 8 | 1SV16CV404 | RAHUL M | M | IV YEAR | CV |
| 9 | 1SV16CV406 | SANNAKKI CHANDRASHEKHARA | M | IV YEAR | CV |
| 10 | 1SV16CV407 | SANTHOSH KUMAR G K | M | IV YEAR | CV |

KABADDI

| SLNO | USN | NAME OF THE STUDENT | GENDER | YEAR | BRANCH |
|------|------------|--------------------------|--------|----------|--------|
| 1 | 1SV12CV002 | AKSHAY C J | M | IV YEAR | CV |
| 2 | 1SV12CV035 | RAGHAVENDRA A | M | IV YEAR | CV |
| 3 | 1SV13CV023 | KENTO LOYA | M | IV YEAR | CV |
| 4 | 1SV13CV035 | MOIRANGTHEM HEMJIT SINGH | M | IV YEAR | CV |
| 5 | 1SV15CV054 | SOMANAGOUDA BIRADAR | M | III YEAR | CV |
| 6 | 1SV14CV046 | VENKATESH N | M | IV YEAR | CV |
| 7 | 1SV15CV007 | AZIMULLA KHAN D | M | III YEAR | CV |
| 8 | 1SV15CV015 | GANESH S D | M | III YEAR | CV |
| 9 | 1SV15CV045 | RAKSHITH J | M | III YEAR | CV |
| 10 | 1SV17CV025 | BLI DAGO EVARISTE | M | II YEAR | CV |
| 11 | 1SV17CV027 | NAWAZ KHAN KN | M | II YEAR | CV |
| 12 | 1SV17CV013 | PUNITHKUMAR K B | M | II YEAR | CV |

SHATAL BADMINTON

| SLNO | USN | NAME OF THE STUDENT | GENDER | YEAR | BRANCH |
|------|------------|-----------------------------|--------|----------|--------|
| 1 | 1SV17CV008 | JAYAMANJUSH CHOUDRI | M | II YEAR | CV |
| 2 | 1SV15CV006 | AURANGZEB ALAM ANSARI | M | III YEAR | CV |
| 3 | 1SV15CV007 | AZIMULLA KHAN D | M | III YEAR | CV |
| 4 | 1SV16CV406 | SANNAKKI CHANDRASHEKHARA | M | IV YEAR | CV |
| 5 | 1SV16CV413 | MOUNESH S RATHOD | M | IV YEAR | CV |

BASKET BALL

| SLNO | USN | NAME OF THE STUDENT | GENDER | YEAR | BRANCH |
|------|------------|--------------------------|--------|----------|--------|
| 1 | 1SV12CV002 | AKSHAY C J | M | IV YEAR | CV |
| 2 | 1SV12CV035 | RAGHAVENDRA A | M | IV YEAR | CV |
| 3 | 1SV13CV023 | KENTO LOYA | M | IV YEAR | CV |
| 4 | 1SV13CV035 | MOIRANGTHEM HEMJIT SINGH | M | IV YEAR | CV |
| 5 | 1SV17CV025 | BLI DAGO EVARISTE | M | II YEAR | CV |
| 6 | 1SV17CV027 | NAWAZ KHAN KN | M | II YEAR | CV |
| 7 | 1SV17CV026 | RAVI TEJU M | M | II YEAR | CV |
| 8 | 1SV15CV006 | AURANGZEB ALAM ANSARI | M | III YEAR | CV |
| 9 | 1SV15CV054 | SOMANAGOUDA BIRADAR | M | III YEAR | CV |
| 10 | 1SV15CV015 | GANESH S D | M | III YEAR | CV |

CAROM

| SLNO | USN | NAME OF THE STUDENT | GENDER | YEAR | BRANCH |
|------|------------|---------------------|--------|----------|--------|
| 1 | 1SV15CV054 | SOMANAGOUDA BIRADAR | M | III YEAR | CV |
| 2 | 1SV18CV412 | PAVAN | M | II YEAR | CV |

CHESS

| SLNO | USN | NAME OF THE STUDENT | GENDER | YEAR | BRANCH |
|------|------------|---------------------|--------|---------|--------|
| 1 | 1SV17CV013 | PUNITHKUMAR K B | M | II YEAR | CV |
| 2 | 1SV16CV409 | SHIVAYOGI B SALAKI | M | IV YEAR | CV |

TABLE TENNIS

| SLNO | USN | NAME OF THE STUDENT | GENDER | YEAR | BRANCH |
|------|------------|---------------------|--------|---------|--------|
| 1 | 1SV12CV035 | RAGHAVENDRA A | M | IV YEAR | CV |
| 2 | 1SV13CV023 | KENTO LOYA | M | IV YEAR | CV |

HAND BALL

| SLNO | USN | NAME OF THE STUDENT | GENDER | YEAR | BRANCH |
|------|------------|-----------------------|--------|----------|--------|
| 1 | 1SV15CV048 | SHAIK MEHBOOB SUBHANI | M | IV YEAR | CV |
| 2 | 1SV15CV049 | SHARATH N | M | IV YEAR | CV |
| 3 | 1SV15CV055 | SREE HARI KISHAN | M | IV YEAR | CV |
| 4 | 1SV15CV059 | UMMANNA NAVI | M | IV YEAR | CV |
| 5 | 1SV15CV060 | VENKATESH DESAI | M | IV YEAR | CV |
| 6 | 1SV15CV046 | RAKSHITH R D | M | III YEAR | CV |
| 7 | 1SV15CV054 | SOMANAGOUDA BIRADAR | M | III YEAR | CV |
| 8 | 1SV14CV046 | VENKATESH N | M | IV YEAR | CV |
| 9 | 1SV17CV019 | SHASHI KUMAR KM | M | II YEAR | CV |
| 10 | 1SV18CV419 | VINAY N K | M | II YEAR | CV |
| 11 | 1SV17CV025 | BLI DAGO EVARISTE | M | II YEAR | CV |

FOOT BALL

| SLNO | USN | NAME OF THE STUDENT | GENDER | YEAR | BRANCH |
|------|------------|--------------------------|--------|----------|--------|
| 1 | 1SV17CV007 | HRUTHIK ROHAN N J | M | II YEAR | CV |
| 2 | 1SV17CV023 | UDAY KUMAR GOWDA R V | M | II YEAR | CV |
| 3 | 1SV18CV400 | AJITH KUMAR B N | M | II YEAR | CV |
| 4 | 1SV15CV036 | MANISH CHAUDHARY | M | IV YEAR | CV |
| 5 | 1SV15CV039 | NIRAJ KUMAR CHAUDHARY | M | IV YEAR | CV |
| 6 | 1SV15CV043 | RAJU RIJAL | M | IV YEAR | CV |
| 7 | 1SV16CV413 | MOUNESH S RATHOD | M | IV YEAR | CV |
| 8 | 1SV12CV016 | KISHOR S R | M | IV YEAR | CV |
| 9 | 1SV13CV013 | GEZIT BOY KARAM | M | IV YEAR | CV |
| 10 | 1SV15CV007 | AZIMULLA KHAN D | M | III YEAR | CV |
| 11 | 1SV15CV054 | SOMANAGOUDA BIRADAR | M | III YEAR | CV |
| 12 | 1SV15CV015 | GANESH S D | M | III YEAR | CV |
| 13 | 1SV17CV020 | SHEKHAR MISHRA | M | II YEAR | CV |
| 14 | 1SV17CV008 | JAYAMANJUSH CHOUDRI | M | II YEAR | CV |
| 15 | 1SV17CV010 | LOKESH D | M | II YEAR | CV |
| 16 | 1SV13CV035 | MOIRANGTHEM HEMJIT SINGH | M | IV YEAR | CV |

THROW BALL

| SLNO | USN | NAME OF THE STUDENT | GENDER | YEAR | BRANCH |
|------|------------|----------------------------|--------|----------|--------|
| 1 | 1SV18CV402 | ANUSHA S THIPPANAGOUDRA | F | II YEAR | CV |
| 2 | 1SV18CV403 | BHARATHI S | F | II YEAR | CV |
| 3 | 1SV18CV404 | GAYATHRI K B | F | II YEAR | CV |
| 4 | 1SV18CV405 | HEMAVATHI M L | F | II YEAR | CV |
| 5 | 1SV15CV041 | PALLAVI B | F | III YEAR | CV |
| 6 | 1SV15CV051 | SINDHU S | F | III YEAR | CV |
| 7 | 1SV15CV002 | AMRUTHA K H | F | IV YEAR | CV |
| 8 | 1SV15CV011 | CHAITHRA V G | F | IV YEAR | CV |
| 9 | 1SV15CV018 | JAHNAVI S J | F | IV YEAR | CV |
| 10 | 1SV15CV053 | SIRI T S | F | IV YEAR | CV |
| 11 | 1SV15CV056 | SUSHMA S | F | IV YEAR | CV |
| 12 | 1SV15CV057 | TANUJA N | F | IV YEAR | CV |

KHO KHO

| SLNO | USN | NAME OF THE STUDENT | GENDER | YEAR | BRANCH |
|------|------------|----------------------|--------|----------|--------|
| 1 | 1SV18CV405 | HEMAVATHI M L | F | II YEAR | CV |
| 2 | 1SV15CV018 | JAHNAVI S J | F | IV YEAR | CV |
| 3 | 1SV15CV051 | SINDHU S | F | III YEAR | CV |
| 4 | 1SV17CV012 | NAVYASHREE NK | F | II YEAR | CV |
| 5 | 1SV17CV016 | RAMYA B | F | II YEAR | CV |
| 6 | 1SV15CV050 | SHOBHA C | F | IV YEAR | CV |
| 7 | 1SV15CV052 | SINDHUSHREE H N | F | IV YEAR | CV |
| 8 | 1SV15CV053 | SIRI T S | F | IV YEAR | CV |
| 9 | 1SV15CV056 | SUSHMA S | F | IV YEAR | CV |
| 10 | 1SV15CV062 | RAMYA P | F | IV YEAR | CV |
| 11 | 1SV16CV400 | KAVYASHREE M | F | IV YEAR | CV |
| 12 | 1SV14CV044 | VASANTHA LAKSHMI T D | F | IV YEAR | CV |

BALL BADMINTON

| SLNO | USN | NAME OF THE STUDENT | GENDER | YEAR | BRANCH |
|------|------------|---------------------|--------|----------|--------|
| 1 | 1SV15CV058 | THANU A R | F | IV YEAR | CV |
| 2 | 1SV15CV062 | RAMYA P | F | IV YEAR | CV |
| 3 | 1SV16CV400 | KAVYASHREE M | F | IV YEAR | CV |
| 4 | 1SV15CV029 | LAKSHMI SAGAR R | F | III YEAR | CV |
| 5 | 1SV18CV405 | HEMAVATHI M L | F | II YEAR | CV |
| 6 | 1SV15CV018 | JAHNAVI S J | F | IV YEAR | CV |
| 7 | 1SV15CV051 | SINDHU S | F | III YEAR | CV |
| 8 | 1SV18CV416 | SREE LAKSHMI M A | F | II YEAR | CV |
| 9 | 1SV18CV417 | SUMA K S | F | II YEAR | CV |
| 10 | 1SV17CV022 | SOUMYA HOMBALLI | F | II YEAR | CV |

SHATAL BADMINTON

| SLNO | USN | NAME OF THE STUDENT | GENDER | YEAR | BRANCH |
|------|------------|---------------------|--------|----------|--------|
| 1 | 1SV15CV041 | PALLAVI B | F | III YEAR | CV |

| | | | | | |
|---|------------|-------------|---|----------|----|
| 2 | 1SV15CV002 | AMRUTHA K H | F | IV YEAR | CV |
| 3 | 1SV15CV018 | JAHNAVI S J | F | IV YEAR | CV |
| 4 | 1SV15CV051 | SINDHU S | F | III YEAR | CV |
| 5 | 1SV18CV417 | SUMA K S | F | II YEAR | CV |

CAROM

| SLNO | USN | NAME OF THE STUDENT | GENDER | YEAR | BRANCH |
|------|------------|---------------------|--------|----------|--------|
| 1 | 1SV18CV413 | SANDHYARANI B R | F | II YEAR | CV |
| 2 | 1SV15CV051 | SINDHU S | F | III YEAR | CV |

CHESS

| SLNO | USN | NAME OF THE STUDENT | GENDER | YEAR | BRANCH |
|------|------------|---------------------|--------|---------|--------|
| 1 | 1SV18CV417 | SUMA K S | F | II YEAR | CV |
| 2 | 1SV15CV018 | JAHNAVI S J | F | IV YEAR | CV |

TABLE TENNIS

| SLNO | USN | NAME OF THE STUDENT | GENDER | YEAR | BRANCH |
|------|------------|----------------------|--------|---------|--------|
| 1 | 1SV18CV405 | HEMAVATHI M L | F | II YEAR | CV |
| 2 | 1SV14CV044 | VASANTHA LAKSHMI T D | F | IV YEAR | CV |

HOD
 Dept. of Civil Engineering
 SIET, TUMKUR - 6.

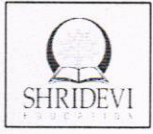

Shridevi Institute of Engineering and Technology,
Tumkur - 572106



DEPARTMENT OF COMPUTER SCIENCE & ENGINEERING

Date: 30-11-2018

It is here by sending list of students participating in Annual Inter department sports activities for the following events

- | | | | |
|---------------------|-------------|------------|----------|
| 1. Throw Ball | : Monday | 03-12-2018 | 11.30 AM |
| 2. Volley Ball | : Tuesday | 04-12-2018 | 2.30 PM |
| 3. Kho Kho | : Thursday | 06-12-2018 | 2.30 PM |
| 4. Cricket | : Friday | 07-12-2018 | 2.30 PM |
| 5. Ball Badminton | : Monday | 10-12-2018 | 2.30 PM |
| 6. Kabaddi | : Monday | 10-12-2018 | 2.30 PM |
| 7. Shatal Badminton | : Tuesday | 11-12-2018 | 2.30 PM |
| 8. Basketball | : Wednesday | 12-12-2018 | 2.30 PM |
| 9. Carom | : Thursday | 13-12-2018 | 2.30 PM |
| 10. Chess | : Thursday | 13-12-2018 | 2.30 PM |
| 11. Table Tennis | : Friday | 14-12-2018 | 2.30 PM |
| 12. Gim | : Saturday | 15-12-2018 | 10.30 AM |
| 13. Hand ball | : Monday | 17-12-2018 | 11.30 AM |
| 14. Foot Ball | : Tuesday | 18-12-2018 | 2.30 PM |

Sports Coordinator

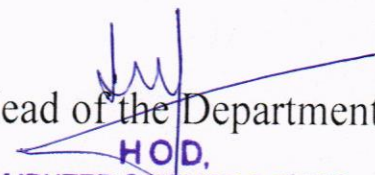
Head of the Department
HOD,
COMPUTER SCIENCE & ENGG.,
SIET, TUMAKURU-06.



DEPARTMENT OF INFORMATION SCIENCE & ENGINEERING

Date: 30-11-2018

It is here by sending list of students participating in Annual Inter department sports activities for the following events

1. Throw Ball : Monday 03-12-2018 11.30 AM
2. Volley Ball : Tuesday 04-12-2018 2.30 PM
3. Kho Kho : Thursday 06-12-2018 2.30 PM
4. Cricket : Friday 07-12-2018 2.30 PM
5. Ball Badminton : Monday 10-12-2018 2.30 PM
6. Kabaddi : Monday 10-12-2018 2.30 PM
7. Shatal Badminton : Tuesday 11-12-2018 2.30 PM
8. Basketball : Wednesday 12-12-2018 2.30 PM
9. Carom : Thursday 13-12-2018 2.30 PM
10. Chess : Thursday 13-12-2018 2.30 PM
11. Table Tennis : Friday 14-12-2018 2.30 PM
12. Gim : Saturday 15-12-2018 10.30 AM
13. Hand ball : Monday 17-12-2018 11.30 AM
14. Foot Ball : Tuesday 18-12-2018 2.30 PM

Sports Coordinator

Head of the Department

HOD
Dept. of ISE
SIET, Tumkur 96.

**LIST OF STUDENTS PARTICIPATING IN ANNUAL INTERDEPARTMENTAL
ANNUAL SPORTS ACTIVITY 2018-19
CSE & ISE**

| THROW BALL | | | | | |
|------------|------------|--------------------------|--------|----------|--------|
| SLNO | USN | NAME OF THE STUDENT | GENDER | YEAR | BRANCH |
| 1 | 1SV15CS047 | MOHAMMED AGHA | M | II YEAR | CSE |
| 2 | 1SV17CS001 | ABHISHEK KUMAR PRASAD | M | II YEAR | CSE |
| 3 | 1SV17CS002 | ABHISHEK PANDEY | M | II YEAR | CSE |
| 4 | 1SV17CS004 | AMAN PRASAD KALWAR | M | II YEAR | CSE |
| 5 | 1SV17CS005 | ANIL GOWDA | M | II YEAR | CSE |
| 6 | 1SV15CS087 | SHIVALEELA BISTANAGOUDAR | M | III YEAR | CSE |
| 7 | 1SV15CS090 | SHUBHAM HUNSHAL | M | III YEAR | CSE |
| 8 | 1SV14CS008 | BHARATH P R | M | IV YEAR | CSE |
| 9 | 1SV14CS009 | BHARATHA C HEGADE | M | IV YEAR | CSE |
| 10 | 1SV17IS001 | NITHIN KUMAR B N | M | II YEAR | IS |
| 11 | 1SV17IS004 | SANTHOSHBHARADWAJ H A | M | II YEAR | IS |
| 12 | 1SV15IS017 | SUSHANTH A JAIN | M | IV YEAR | IS |

| VOLLEY BALL | | | | | |
|-------------|------------|-----------------------|--------|----------|--------|
| SLNO | USN | NAME OF THE STUDENT | GENDER | YEAR | BRANCH |
| 1 | 1SV17CS005 | ANIL GOWDA | M | II YEAR | CSE |
| 2 | 1SV17CS008 | B RAMESH | M | II YEAR | CSE |
| 3 | 1SV17CS013 | CHETHAN D | M | II YEAR | CSE |
| 4 | 1SV17CS021 | KRUPANKH D N | M | II YEAR | CSE |
| 5 | 1SV17CS042 | VIJAY KUMAR JHA | M | II YEAR | CSE |
| 6 | 1SV14CS036 | MIDHILA MURALI | M | III YEAR | CSE |
| 7 | 1SV15CS001 | ADITYA SHAH | M | III YEAR | CSE |
| 8 | 1SV14CS009 | BHARATHA C HEGADE | M | IV YEAR | CSE |
| 9 | 1SV17IS001 | NITHIN KUMAR B N | M | II YEAR | IS |
| 10 | 1SV17IS004 | SANTHOSHBHARADWAJ H A | M | II YEAR | IS |
| 11 | 1SV15IS009 | NARASIMHAMURTHY N | M | III YEAR | IS |
| 12 | 1SV15IS014 | SAGAR R | M | III YEAR | IS |

| KHO KHO | | | | | |
|---------|------------|---------------------|--------|----------|--------|
| SLNO | USN | NAME OF THE STUDENT | GENDER | YEAR | BRANCH |
| 1 | 1SV14CS057 | ROHAN B P | M | IV YEAR | CSE |
| 2 | 1SV15CS034 | KIRAN A S | M | IV YEAR | CSE |
| 3 | 1SV15CS035 | KUMAR DAHAL | M | IV YEAR | CSE |
| 4 | 1SV15CS043 | MEER KAREE MUDDIN | M | III YEAR | CSE |
| 5 | 1SV15CS049 | MUKESH REDDY K A | M | III YEAR | CSE |
| 6 | 1SV15CS079 | RAVI UJJWAL | M | III YEAR | CSE |
| 7 | 1SV17CS035 | RAJESH KUMAR KAHAR | M | II YEAR | CSE |
| 8 | 1SV17CS037 | SADANAND KUMAR | M | II YEAR | CSE |
| 9 | 1SV17CS038 | SAURABH PANDEY | M | II YEAR | CSE |
| 10 | 1SV15IS009 | NARASIMHAMURTHY N | M | III YEAR | IS |
| 11 | 1SV15IS014 | SAGAR R | M | III YEAR | IS |
| 12 | 1SV15IS008 | MADHAN J | M | IV YEAR | IS |

| CRICKET | | | | | |
|---------|------------|--------------------------|--------|----------|--------|
| SLNO | USN | NAME OF THE STUDENT | GENDER | YEAR | BRANCH |
| 1 | 1SV17CS025 | MAYANK SINHA | M | II YEAR | CSE |
| 2 | 1SV17CS030 | NIKESH KUMAR TIWARI | M | II YEAR | CSE |
| 3 | 1SV15CS028 | K S SANATH KUMAR | M | III YEAR | CSE |
| 4 | 1SV15CS038 | DAVANAND SANGANNA SHYANA | M | III YEAR | CSE |
| 5 | 1SV15CS051 | NAGARAJ V H | M | IV YEAR | CSE |

| | | | | | |
|----|------------|-----------------------|---|----------|-----|
| 6 | 1SV15CS063 | PAVAN K P | M | IV YEAR | CSE |
| 7 | 1SV15CS073 | RAGHUNATH H P | M | IV YEAR | CSE |
| 8 | 1SV15CS084 | SHAMANTH H S | M | IV YEAR | CSE |
| 9 | 1SV17IS001 | NITHIN KUMAR B N | M | II YEAR | IS |
| 10 | 1SV17IS004 | SANTHOSHBHARADWAJ H A | M | II YEAR | IS |
| 11 | 1SV15IS009 | NARASIMHAMURTHY N | M | III YEAR | IS |
| 12 | 1SV15IS014 | SAGAR R | M | III YEAR | IS |
| 13 | 1SV15IS008 | MADHAN J | M | IV YEAR | IS |
| 14 | 1SV15IS010 | NITHIN S D | M | IV YEAR | IS |
| 15 | 1SV15IS017 | SUSHANTH A JAIN | M | IV YEAR | IS |

| BALL BADMINTON | | | | | |
|----------------|------------|-----------------------|--------|----------|--------|
| SLNO | USN | NAME OF THE STUDENT | GENDER | YEAR | BRANCH |
| 1 | 1SV17CS004 | AMAN PRASAD KALWAR | M | II YEAR | CSE |
| 2 | 1SV17CS005 | ANIL GOWDA | M | II YEAR | CSE |
| 3 | 1SV17CS008 | B RAMESH | M | II YEAR | CSE |
| 4 | 1SV15CS049 | MUKESH REDDY K A | M | III YEAR | CSE |
| 5 | 1SV15CS079 | RAVI UJJWAL | M | III YEAR | CSE |
| 6 | 1SV15CS082 | SAGAR B R | M | III YEAR | CSE |
| 7 | 1SV14CS009 | BHARATHA C HEGADE | M | IV YEAR | CSE |
| 8 | 1SV17IS001 | NITHIN KUMAR B N | M | II YEAR | IS |
| 9 | 1SV17IS004 | SANTHOSHBHARADWAJ H A | M | II YEAR | IS |
| 10 | 1SV15IS017 | SUSHANTH A JAIN | M | IV YEAR | IS |

| KABADDI | | | | | |
|---------|------------|----------------------------|--------|----------|--------|
| SLNO | USN | NAME OF THE STUDENT | GENDER | YEAR | BRANCH |
| 1 | 1SV15CS047 | MOHAMMED AGHA | M | II YEAR | CSE |
| 2 | 1SV17CS001 | ABHISHEK KUMAR PRASAD | M | II YEAR | CSE |
| 3 | 1SV15CS001 | ADITYA SHAH | M | III YEAR | CSE |
| 4 | 1SV15CS009 | BEERAM TEJA SREE | M | III YEAR | CSE |
| 5 | 1SV15CS040 | MALI ASHWINI MALLESHI | M | IV YEAR | CSE |
| 6 | 1SV15CS048 | MOHAMMED ZUBAIR SIDDIQUE R | M | IV YEAR | CSE |
| 7 | 1SV15CS051 | NAGARAJ V H | M | IV YEAR | CSE |
| 8 | 1SV15CS063 | PAVAN K P | M | IV YEAR | CSE |
| 9 | 1SV17IS004 | SANTHOSHBHARADWAJ H A | M | II YEAR | IS |
| 10 | 1SV15IS009 | NARASIMHAMURTHY N | M | III YEAR | IS |
| 11 | 1SV15IS014 | SAGAR R | M | III YEAR | IS |
| 12 | 1SV15IS008 | MADHAN J | M | IV YEAR | IS |

| SHATAL BADMINTON | | | | | |
|------------------|------------|----------------------------|--------|----------|--------|
| SLNO | USN | NAME OF THE STUDENT | GENDER | YEAR | BRANCH |
| 1 | 1SV15CS040 | MALI ASHWINI MALLESHI | M | IV YEAR | CSE |
| 2 | 1SV15CS048 | MOHAMMED ZUBAIR SIDDIQUE R | M | IV YEAR | CSE |
| 3 | 1SV15IS014 | SAGAR R | M | III YEAR | IS |
| 4 | 1SV15IS008 | MADHAN J | M | IV YEAR | IS |
| 5 | 1SV15IS017 | SUSHANTH A JAIN | M | IV YEAR | IS |

| BASKET BALL | | | | | |
|-------------|------------|-----------------------|--------|----------|--------|
| SLNO | USN | NAME OF THE STUDENT | GENDER | YEAR | BRANCH |
| 1 | 1SV14CS008 | BHARATH P R | M | IV YEAR | CSE |
| 2 | 1SV14CS009 | BHARATHA C HEGADE | M | IV YEAR | CSE |
| 3 | 1SV17IS004 | SANTHOSHBHARADWAJ H A | M | II YEAR | IS |
| 4 | 1SV15IS009 | NARASIMHAMURTHY N | M | III YEAR | IS |
| 5 | 1SV15CS034 | KIRAN A S | M | IV YEAR | CSE |
| 6 | 1SV15CS035 | KUMAR DAHAL | M | IV YEAR | CSE |

| | | | | | |
|----|------------|--------------------|---|----------|-----|
| 7 | 1SV14CS036 | MIDHILA MURALI | M | III YEAR | CSE |
| 8 | 1SV15CS001 | ADITYA SHAH | M | III YEAR | CSE |
| 9 | 1SV17CS002 | ABHISHEK PANDEY | M | II YEAR | CSE |
| 10 | 1SV17CS004 | AMAN PRASAD KALWAR | M | II YEAR | CSE |

| CAROM | | | | | |
|-------|------------|-----------------------|--------|---------|--------|
| SLNO | USN | NAME OF THE STUDENT | GENDER | YEAR | BRANCH |
| 1 | 1SV17CS001 | ABHISHEK KUMAR PRASAD | M | II YEAR | CSE |
| 2 | 1SV17IS004 | SANTHOSHBHARADWAJ H A | M | II YEAR | IS |

| CHESS | | | | | |
|-------|------------|----------------------------|--------|---------|--------|
| SLNO | USN | NAME OF THE STUDENT | GENDER | YEAR | BRANCH |
| 1 | 1SV15CS085 | SHARON BIJU GEORGE | M | IV YEAR | CSE |
| 2 | 1SV15CS048 | MOHAMMED ZUBAIR SIDDIQUE R | M | IV YEAR | CSE |

| TABLE TENNIS | | | | | |
|--------------|------------|---------------------|--------|---------|--------|
| SLNO | USN | NAME OF THE STUDENT | GENDER | YEAR | BRANCH |
| 1 | 1SV14CS009 | BHARATHA C HEGADE | M | IV YEAR | CSE |
| 2 | 1SV17IS001 | NITHIN KUMAR B N | M | II YEAR | IS |

| HAND BALL | | | | | |
|-----------|------------|---------------------|--------|----------|--------|
| SLNO | USN | NAME OF THE STUDENT | GENDER | YEAR | BRANCH |
| 1 | 1SV14CS057 | ROHAN B P | M | IV YEAR | CSE |
| 2 | 1SV15CS034 | KIRAN A S | M | IV YEAR | CSE |
| 3 | 1SV15CS043 | MEER KAREE MUDDIN | M | III YEAR | CSE |
| 4 | 1SV15CS049 | MUKESH REDDY K A | M | III YEAR | CSE |
| 5 | 1SV17CS033 | PRUTHVIRAJ R B | M | II YEAR | CSE |
| 6 | 1SV17CS035 | RAJESH KUMAR KAHAR | M | II YEAR | CSE |
| 7 | 1SV17CS037 | SADANAND KUMAR | M | II YEAR | CSE |
| 8 | 1SV15IS014 | SAGAR R | M | III YEAR | IS |
| 9 | 1SV15IS008 | MADHAN J | M | IV YEAR | IS |
| 10 | 1SV15IS010 | NITHIN S D | M | IV YEAR | IS |
| 11 | 1SV15IS017 | SUSHANTH A JAIN | M | IV YEAR | IS |

| THROW BALL | | | | | |
|------------|------------|---------------------|--------|----------|--------|
| SLNO | USN | NAME OF THE STUDENT | GENDER | YEAR | BRANCH |
| 1 | 1SV15CS070 | PRIYA PANDA | F | II YEAR | CSE |
| 2 | 1SV17CS003 | AISHWARYA MERY E | F | II YEAR | CSE |
| 3 | 1SV17CS006 | ANUPRIYA SINGH | F | II YEAR | CSE |
| 4 | 1SV17CS009 | BHOOMIKA M | F | II YEAR | CSE |
| 5 | 1SV17CS012 | CHANDANA D GOWDA | F | II YEAR | CSE |
| 6 | 1SV17CS014 | EVA REGMI | F | II YEAR | CSE |
| 7 | 1SV17CS016 | HARSHITHA B A | F | II YEAR | CSE |
| 8 | 1SV15CS012 | BHAVYA B | F | III YEAR | CSE |
| 9 | 1SV15CS022 | HARSHITHA B C | F | III YEAR | CSE |
| 10 | 1SV15CS042 | MEENAKSHI P | F | III YEAR | CSE |
| 11 | 1SV15CS053 | NARGIS NAAZ | F | III YEAR | CSE |
| 12 | 1SV14IS005 | DEEPTHI K S | F | IV YEAR | IS |

| KHO KHO | | | | | |
|---------|------------|---------------------|--------|----------|--------|
| SLNO | USN | NAME OF THE STUDENT | GENDER | YEAR | BRANCH |
| 1 | 1SV17CS014 | EVA REGMI | F | II YEAR | CSE |
| 2 | 1SV17CS016 | HARSHITHA B A | F | II YEAR | CSE |
| 3 | 1SV15IS005 | HEMASHREE M | F | IV YEAR | IS |
| 4 | 1SV15IS007 | LAKSHMIDEVI | F | IV YEAR | IS |
| 5 | 1SV15IS011 | NIVEDITHA S | F | IV YEAR | IS |
| 6 | 1SV15IS015 | SHRAVYA P | F | IV YEAR | IS |
| 7 | 1SV15CS099 | SYEDA HABIB UNNISA | F | IV YEAR | CSE |
| 8 | 1SV15CS100 | THANUSHREE T | F | IV YEAR | CSE |
| 9 | 1SV15CS102 | VIMALA T | F | IV YEAR | CSE |
| 10 | 1SV15CS104 | VYSIRI DEV | F | IV YEAR | CSE |
| 11 | 1SV15CS106 | YASHASWINI B M | F | IV YEAR | CSE |
| 12 | 1SV15CS067 | POOJA K S | F | III YEAR | CSE |

| BALL BADMINTON | | | | | |
|----------------|------------|---------------------|--------|----------|--------|
| SLNO | USN | NAME OF THE STUDENT | GENDER | YEAR | BRANCH |
| 1 | 1SV17CS014 | EVA REGMI | F | II YEAR | CSE |
| 2 | 1SV16CS002 | MEGHASHREE B | F | III YEAR | CSE |
| 3 | 1SV16CS402 | MEGHANA S B | F | III YEAR | CSE |
| 4 | 1SV14CS006 | ANUSHREE K S | F | IV YEAR | CSE |
| 5 | 1SV15CS003 | AMEENA FARHEEN | F | IV YEAR | CSE |
| 6 | 1SV15IS001 | BHOOMIKA B S | F | IV YEAR | IS |
| 7 | 1SV15IS002 | CHETANA K S | F | IV YEAR | IS |
| 8 | 1SV15IS005 | HEMASHREE M | F | IV YEAR | IS |
| 9 | 1SV14IS005 | DEEPTHI K S | F | IV YEAR | IS |
| 10 | 1SV15CS100 | THANUSHREE T | F | IV YEAR | CSE |

| SHATAL BADMINTON | | | | | |
|------------------|------------|---------------------|--------|---------|--------|
| SLNO | USN | NAME OF THE STUDENT | GENDER | YEAR | BRANCH |
| 1 | 1SV15CS102 | VIMALA T | F | IV YEAR | CSE |
| 2 | 1SV15CS104 | VYSIRI DEV | F | IV YEAR | CSE |
| 3 | 1SV15IS007 | LAKSHMIDEVI | F | IV YEAR | IS |
| 4 | 1SV15IS011 | NIVEDITHA S | F | IV YEAR | IS |
| 5 | 1SV14IS005 | DEEPTHI K S | F | IV YEAR | IS |

| CARROM | | | | | |
|--------|------------|---------------------|--------|---------|--------|
| SLNO | USN | NAME OF THE STUDENT | GENDER | YEAR | BRANCH |
| 1 | 1SV17CS014 | EVA REGMI | F | II YEAR | CSE |
| 2 | 1SV17IS003 | RAKIYA UZMA | F | II YEAR | IS |

| CHESS | | | | | |
|-------|------------|---------------------|--------|----------|--------|
| SLNO | USN | NAME OF THE STUDENT | GENDER | YEAR | BRANCH |
| 1 | 1SV15CS101 | VARSHITHA R M | F | III YEAR | CSE |
| 2 | 1SV15IS004 | GOWTHAMI C | F | III YEAR | IS |

| TABLE TENNIS | | | | | |
|--------------|------------|---------------------|--------|---------|--------|
| SLNO | USN | NAME OF THE STUDENT | GENDER | YEAR | BRANCH |
| 1 | 1SV15CS401 | KAVYA J N | F | IV YEAR | CSE |
| 2 | 1SV17IS002 | RACHANA V | F | II YEAR | IS |

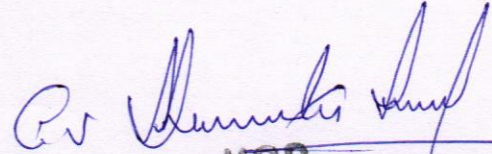
HOD.
COMPUTER SCIENCE & ENGG.,
SIET, TUMAKURU-06.



Shridevi Institute of Engineering and Technology, Tumkur - 572106



DEPARTMENT OF ELECTRONICS & COMMUNICATION ENGINEERING

Date: 02-12-2018

It is here by sending list of students participating in Annual Inter department sports activities for the following events

- | | | | |
|---------------------|-------------|------------|----------|
| 1. Throw Ball | : Monday | 03-12-2018 | 11.30 AM |
| 2. Volley Ball | : Tuesday | 04-12-2018 | 2.30 PM |
| 3. Kho Kho | : Thursday | 06-12-2018 | 2.30 PM |
| 4. Cricket | : Friday | 07-12-2018 | 2.30 PM |
| 5. Ball Badminton | : Monday | 10-12-2018 | 2.30 PM |
| 6. Kabaddi | : Monday | 10-12-2018 | 2.30 PM |
| 7. Shatal Badminton | : Tuesday | 11-12-2018 | 2.30 PM |
| 8. Basketball | : Wednesday | 12-12-2018 | 2.30 PM |
| 9. Carom | : Thursday | 13-12-2018 | 2.30 PM |
| 10. Chess | : Thursday | 13-12-2018 | 2.30 PM |
| 11. Table Tennis | : Friday | 14-12-2018 | 2.30 PM |
| 12. Gim | : Saturday | 15-12-2018 | 10.30 AM |
| 13. Hand ball | : Monday | 17-12-2018 | 11.30 AM |
| 14. Foot Ball | : Tuesday | 18-12-2018 | 2.30 PM |

Sports Coordinator

Head of the Department
HOD
Dept of E&C
SIET, Tumkur-6

**LIST OF STUDENTS PARTICIPATING IN ANNUAL INTERDEPARTMENTAL,
ANNUAL SPORTS ACTIVITY 2018-19**

| THROW BALL | | | | | |
|------------|------------|----------------------|--------|----------|--------|
| SLNO | USN | NAME OF THE STUDENT | GENDER | YEAR | BRANCH |
| 1 | 1SV15EC025 | NITHIN KUMAR G M | M | II YEAR | ECE |
| 2 | 1SV17EC003 | DANIEL S | M | II YEAR | ECE |
| 3 | 1SV17EC005 | JITHENDRA H | M | II YEAR | ECE |
| 4 | 1SV17EC006 | MD TAJ HUSSAIN | M | II YEAR | ECE |
| 5 | 1SV17EC009 | NISHATH NAWAZ | M | II YEAR | ECE |
| 6 | 1SV17EC011 | RAKESH K L | M | II YEAR | ECE |
| 7 | 1SV18EC402 | LOKESHA G H | M | II YEAR | ECE |
| 8 | 1SV15EC005 | ARUN C G | M | III YEAR | ECE |
| 9 | 1SV15EC035 | RAGHURAJ G K | M | III YEAR | ECE |
| 10 | 1SV15EC052 | VISHWAS S P | M | III YEAR | ECE |
| 11 | 1SV15EC001 | ABHISHEK G SHEELVANT | M | IV YEAR | ECE |
| 12 | 1SV15EC009 | CL BALAJI | M | IV YEAR | ECE |

| VOLLEY BALL | | | | | |
|-------------|------------|--------------------------|--------|----------|--------|
| SLNO | USN | NAME OF THE STUDENT | GENDER | YEAR | BRANCH |
| 1 | 1SV15EC035 | RAGHURAJ G K | M | III YEAR | ECE |
| 2 | 1SV15EC052 | VISHWAS S P | M | III YEAR | ECE |
| 3 | 1SV15EC001 | ABHISHEK G SHEELVANT | M | IV YEAR | ECE |
| 4 | 1SV15EC009 | CL BALAJI | M | IV YEAR | ECE |
| 5 | 1SV15EC032 | PRASHANT CHOUDRI | M | IV YEAR | ECE |
| 6 | 1SV15EC040 | ROHITH P | M | IV YEAR | ECE |
| 7 | 1SV15EC051 | VINAY S P | M | IV YEAR | ECE |
| 8 | 1SV16EC400 | ABDUL NAZEERSAB A KANAVA | M | IV YEAR | ECE |
| 9 | 1SV16EC404 | CHIRANJEEVI K M | M | IV YEAR | ECE |
| 10 | 1SV16EC407 | MANJUNATH B YANNI | M | IV YEAR | ECE |
| 11 | 1SV15EC025 | NITHIN KUMAR G M | M | II YEAR | ECE |
| 12 | 1SV17EC003 | DANIEL S | M | II YEAR | ECE |

| KHO KHO | | | | | |
|---------|------------|---------------------|--------|----------|--------|
| SLNO | USN | NAME OF THE STUDENT | GENDER | YEAR | BRANCH |
| 1 | 1SV16EC408 | MOHANKUMAR D | M | IV YEAR | ECE |
| 2 | 1SV13EC012 | DILEEP S | M | IV YEAR | ECE |
| 3 | 1SV13EC020 | KEERTHY N | M | IV YEAR | ECE |
| 4 | 1SV13EC059 | Y MAHESH SINGH | M | IV YEAR | ECE |
| 5 | 1SV14EC002 | ANJU N | M | IV YEAR | ECE |
| 6 | 1SV14EC408 | SUPREETH C | M | IV YEAR | ECE |
| 7 | 1SV17EC009 | NISHATH NAWAZ | M | II YEAR | ECE |
| 8 | 1SV17EC011 | RAKESH K L | M | II YEAR | ECE |
| 9 | 1SV18EC402 | LOKESHA G H | M | II YEAR | ECE |
| 10 | 1SV15EC005 | ARUN C G | M | III YEAR | ECE |
| 11 | 1SV15EC035 | RAGHURAJ G K | M | III YEAR | ECE |
| 12 | 1SV15EC052 | VISHWAS S P | M | III YEAR | ECE |

| CRICKET | | | | | |
|---------|------------|---------------------|--------|----------|--------|
| SLNO | USN | NAME OF THE STUDENT | GENDER | YEAR | BRANCH |
| 1 | 1SV17EC005 | JITHENDRA H | M | II YEAR | ECE |
| 2 | 1SV17EC006 | MD TAJ HUSSAIN | M | II YEAR | ECE |
| 3 | 1SV17EC009 | NISHATH NAWAZ | M | II YEAR | ECE |
| 4 | 1SV17EC011 | RAKESH K L | M | II YEAR | ECE |
| 5 | 1SV18EC402 | LOKESHA G H | M | II YEAR | ECE |
| 6 | 1SV15EC005 | ARUN C G | M | III YEAR | ECE |
| 7 | 1SV15EC035 | RAGHURAJ G K | M | III YEAR | ECE |

| | | | | | |
|----|------------|--------------------------|---|----------|-----|
| 8 | 1SV15EC052 | VISHWAS S P | M | III YEAR | ECE |
| 9 | 1SV15EC001 | ABHISHEK G SHEELVANT | M | IV YEAR | ECE |
| 10 | 1SV15EC009 | CL BALAJI | M | IV YEAR | ECE |
| 11 | 1SV15EC032 | PRASHANT CHOUDRI | M | IV YEAR | ECE |
| 12 | 1SV15EC040 | ROHITH P | M | IV YEAR | ECE |
| 13 | 1SV15EC051 | VINAY S P | M | IV YEAR | ECE |
| 14 | 1SV16EC400 | ABDUL NAZEERSAB A KANAVA | M | IV YEAR | ECE |
| 15 | 1SV16EC404 | CHIRANJEEVI K M | M | IV YEAR | ECE |

| BALL BADMINTON | | | | | |
|----------------|------------|--------------------------|--------|----------|--------|
| SLNO | USN | NAME OF THE STUDENT | GENDER | YEAR | BRANCH |
| 1 | 1SV15EC025 | NITHIN KUMAR G M | M | II YEAR | ECE |
| 2 | 1SV17EC003 | DANIEL S | M | II YEAR | ECE |
| 3 | 1SV17EC005 | JITHENDRA H | M | II YEAR | ECE |
| 4 | 1SV13EC012 | DILEEP S | M | IV YEAR | ECE |
| 5 | 1SV13EC020 | KEERTHY N | M | IV YEAR | ECE |
| 6 | 1SV13EC059 | Y MAHESH SINGH | M | IV YEAR | ECE |
| 7 | 1SV15EC005 | ARUN C G | M | III YEAR | ECE |
| 8 | 1SV15EC035 | RAGHURAJ G K | M | III YEAR | ECE |
| 9 | 1SV15EC052 | VISHWAS S P | M | III YEAR | ECE |
| 10 | 1SV16EC400 | ABDUL NAZEERSAB A KANAVA | M | IV YEAR | ECE |

| KABADDI | | | | | |
|---------|------------|---------------------|--------|----------|--------|
| SLNO | USN | NAME OF THE STUDENT | GENDER | YEAR | BRANCH |
| 1 | 1SV16EC407 | MANJUNATH B YANNI | M | IV YEAR | ECE |
| 2 | 1SV16EC408 | MOHANKUMAR D | M | IV YEAR | ECE |
| 3 | 1SV13EC012 | DILEEP S | M | IV YEAR | ECE |
| 4 | 1SV13EC020 | KEERTHY N | M | IV YEAR | ECE |
| 5 | 1SV13EC059 | Y MAHESH SINGH | M | IV YEAR | ECE |
| 6 | 1SV14EC002 | ANJU N | M | IV YEAR | ECE |
| 7 | 1SV14EC408 | SUPREETH C | M | IV YEAR | ECE |
| 8 | 1SV17EC009 | NISHATH NAWAZ | M | II YEAR | ECE |
| 9 | 1SV17EC011 | RAKESH K L | M | II YEAR | ECE |
| 10 | 1SV18EC402 | LOKESHA G H | M | II YEAR | ECE |
| 11 | 1SV15EC005 | ARUN C G | M | III YEAR | ECE |
| 12 | 1SV15EC035 | RAGHURAJ G K | M | III YEAR | ECE |

| SHATAL BADMINTON | | | | | |
|------------------|------------|----------------------|--------|----------|--------|
| SLNO | USN | NAME OF THE STUDENT | GENDER | YEAR | BRANCH |
| 1 | 1SV17EC006 | MD TAJ HUSSAIN | M | II YEAR | ECE |
| 2 | 1SV15EC035 | RAGHURAJ G K | M | III YEAR | ECE |
| 3 | 1SV15EC052 | VISHWAS S P | M | III YEAR | ECE |
| 4 | 1SV15EC001 | ABHISHEK G SHEELVANT | M | IV YEAR | ECE |
| 5 | 1SV15EC009 | CL BALAJI | M | IV YEAR | ECE |

| BASKET BALL | | | | | |
|-------------|------------|--------------------------|--------|----------|--------|
| SLNO | USN | NAME OF THE STUDENT | GENDER | YEAR | BRANCH |
| 1 | 1SV15EC052 | VISHWAS S P | M | III YEAR | ECE |
| 2 | 1SV15EC001 | ABHISHEK G SHEELVANT | M | IV YEAR | ECE |
| 3 | 1SV15EC009 | CL BALAJI | M | IV YEAR | ECE |
| 4 | 1SV15EC032 | PRASHANT CHOUDRI | M | IV YEAR | ECE |
| 5 | 1SV15EC040 | ROHITH P | M | IV YEAR | ECE |
| 6 | 1SV15EC051 | VINAY S P | M | IV YEAR | ECE |
| 7 | 1SV16EC400 | ABDUL NAZEERSAB A KANAVA | M | IV YEAR | ECE |
| 8 | 1SV17EC005 | JITHENDRA H | M | II YEAR | ECE |
| 9 | 1SV18EC402 | LOKESHA G H | M | II YEAR | ECE |
| 10 | 1SV15EC005 | ARUN C G | M | III YEAR | ECE |

| CAROM | | | | | |
|-------|------------|---------------------|--------|---------|--------|
| SLNO | USN | NAME OF THE STUDENT | GENDER | YEAR | BRANCH |
| 1 | 1SV16EC404 | CHIRANJEEVI K M | M | IV YEAR | ECE |
| 2 | 1SV17EC011 | RAKESH K L | M | II YEAR | ECE |

| CHESS | | | | | |
|-------|------------|---------------------|--------|----------|--------|
| SLNO | USN | NAME OF THE STUDENT | GENDER | YEAR | BRANCH |
| 1 | 1SV17EC005 | JITHENDRA H | M | II YEAR | ECE |
| 2 | 1SV15EC035 | RAGHURAJ G K | M | III YEAR | ECE |

| TABLE TENNIS | | | | | |
|--------------|------------|---------------------|--------|---------|--------|
| SLNO | USN | NAME OF THE STUDENT | GENDER | YEAR | BRANCH |
| 1 | 1SV15EC032 | PRASHANT CHOUDRI | M | IV YEAR | ECE |
| 2 | 1SV15EC040 | ROHITH P | M | IV YEAR | ECE |

| HAND BALL | | | | | |
|-----------|------------|----------------------|--------|----------|--------|
| SLNO | USN | NAME OF THE STUDENT | GENDER | YEAR | BRANCH |
| 1 | 1SV17EC003 | DANIEL S | M | II YEAR | ECE |
| 2 | 1SV17EC005 | JITHENDRA H | M | II YEAR | ECE |
| 3 | 1SV17EC006 | MD TAJ HUSSAIN | M | II YEAR | ECE |
| 4 | 1SV17EC009 | NISHATH NAWAZ | M | II YEAR | ECE |
| 5 | 1SV17EC011 | RAKESH K L | M | II YEAR | ECE |
| 6 | 1SV18EC402 | LOKESHA G H | M | II YEAR | ECE |
| 7 | 1SV15EC005 | ARUN C G | M | III YEAR | ECE |
| 8 | 1SV15EC035 | RAGHURAJ G K | M | III YEAR | ECE |
| 9 | 1SV15EC052 | VISHWAS S P | M | III YEAR | ECE |
| 10 | 1SV15EC001 | ABHISHEK G SHEELVANT | M | IV YEAR | ECE |
| 11 | 1SV15EC009 | CL BALAJI | M | IV YEAR | ECE |

| FOOT BALL | | | | | |
|-----------|------------|--------------------------|--------|----------|--------|
| SLNO | USN | NAME OF THE STUDENT | GENDER | YEAR | BRANCH |
| 1 | 1SV15EC032 | PRASHANT CHOUDRI | M | IV YEAR | ECE |
| 2 | 1SV15EC040 | ROHITH P | M | IV YEAR | ECE |
| 3 | 1SV15EC051 | VINAY S P | M | IV YEAR | ECE |
| 4 | 1SV16EC400 | ABDUL NAZEERSAB A KANAVA | M | IV YEAR | ECE |
| 5 | 1SV16EC404 | CHIRANJEEVI K M | M | IV YEAR | ECE |
| 6 | 1SV16EC407 | MANJUNATH B YANNI | M | IV YEAR | ECE |
| 7 | 1SV16EC408 | MOHANKUMAR D | M | IV YEAR | ECE |
| 8 | 1SV13EC012 | DILEEP S | M | IV YEAR | ECE |
| 9 | 1SV17EC005 | JITHENDRA H | M | II YEAR | ECE |
| 10 | 1SV17EC006 | MD TAJ HUSSAIN | M | II YEAR | ECE |
| 11 | 1SV17EC009 | NISHATH NAWAZ | M | II YEAR | ECE |
| 12 | 1SV17EC011 | RAKESH K L | M | II YEAR | ECE |
| 13 | 1SV18EC402 | LOKESHA G H | M | II YEAR | ECE |
| 14 | 1SV15EC005 | ARUN C G | M | III YEAR | ECE |
| 15 | 1SV15EC035 | RAGHURAJ G K | M | III YEAR | ECE |
| 16 | 1SV15EC025 | NITHIN KUMAR G M | M | II YEAR | ECE |

| THROW BALL | | | | | |
|------------|------------|---------------------|--------|----------|--------|
| SLNO | USN | NAME OF THE STUDENT | GENDER | YEAR | BRANCH |
| 1 | 1SV15EC045 | SUNITHA Y K | F | II YEAR | ECE |
| 2 | 1SV17EC001 | AFRA FATHIMA | F | II YEAR | ECE |
| 3 | 1SV17EC002 | ASHWINI V | F | II YEAR | ECE |
| 4 | 1SV17EC004 | GEETHA M R | F | II YEAR | ECE |
| 5 | 1SV17EC007 | NIDA NAWAZ | F | II YEAR | ECE |
| 6 | 1SV17EC008 | NISHA H | F | II YEAR | ECE |
| 7 | 1SV17EC015 | SAYEEDUNNISA | F | II YEAR | ECE |
| 8 | 1SV15EC027 | NOOR AYESHA | F | III YEAR | ECE |
| 9 | 1SV15EC049 | USHA Y M | F | III YEAR | ECE |
| 10 | 1SV16EC402 | ANUSHA T P | F | III YEAR | ECE |
| 11 | 1SV14EC015 | LAHARI N RAJ | F | IV YEAR | ECE |
| 12 | 1SV15EC002 | AISHWARYA S M | F | IV YEAR | ECE |

| KHO KHO | | | | | |
|---------|------------|---------------------|--------|----------|--------|
| SLNO | USN | NAME OF THE STUDENT | GENDER | YEAR | BRANCH |
| 1 | 1SV16EC412 | RAMYA N K | F | IV YEAR | ECE |
| 2 | 1SV16EC413 | RAMYASHREE M | F | IV YEAR | ECE |
| 3 | 1SV16EC414 | SOWNDARYA A | F | IV YEAR | ECE |
| 4 | 1SV15EC409 | RAMYA B S | F | IV YEAR | ECE |
| 5 | 1SV15EC007 | BHAVANA N | F | III YEAR | ECE |
| 6 | 1SV15EC013 | GAGANA S K | F | III YEAR | ECE |
| 7 | 1SV15EC018 | KAVYA S | F | III YEAR | ECE |
| 8 | 1SV18EC400 | DIVYASHREE N | F | II YEAR | ECE |
| 9 | 1SV18EC401 | HEMA K P | F | II YEAR | ECE |
| 10 | 1SV18EC403 | NIROSHA M V | F | II YEAR | ECE |
| 11 | 1SV17EC014 | SAHANA G R | F | II YEAR | ECE |
| 12 | 1SV17EC015 | SAYEEDUNNISA | F | II YEAR | ECE |

| BALL BADMINTON | | | | | |
|----------------|------------|---------------------|--------|----------|--------|
| SLNO | USN | NAME OF THE STUDENT | GENDER | YEAR | BRANCH |
| 1 | 1SV17EC007 | NIDA NAWAZ | F | II YEAR | ECE |
| 2 | 1SV17EC008 | NISHA H | F | II YEAR | ECE |
| 3 | 1SV17EC013 | REKHA K N | F | II YEAR | ECE |
| 4 | 1SV15EC007 | BHAVANA N | F | III YEAR | ECE |
| 5 | 1SV15EC013 | GAGANA S K | F | III YEAR | ECE |
| 6 | 1SV15EC018 | KAVYA S | F | III YEAR | ECE |
| 7 | 1SV15EC027 | NOOR AYESHA | F | III YEAR | ECE |
| 8 | 1SV15EC016 | HARINI D C | F | IV YEAR | ECE |
| 9 | 1SV15EC017 | S KAVITHA | F | IV YEAR | ECE |
| 10 | 1SV15EC020 | MAMATHA M S | F | IV YEAR | ECE |

| SHATAL BADMINTON | | | | | |
|------------------|------------|---------------------|--------|----------|--------|
| SLNO | USN | NAME OF THE STUDENT | GENDER | YEAR | BRANCH |
| 1 | 1SV15EC028 | PADMA M A | F | IV YEAR | ECE |
| 2 | 1SV15EC030 | POOJA K S | F | IV YEAR | ECE |
| 3 | 1SV15EC027 | NOOR AYESHA | F | III YEAR | ECE |
| 4 | 1SV17EC007 | NIDA NAWAZ | F | II YEAR | ECE |
| 5 | 1SV16EC412 | RAMYA N K | F | IV YEAR | ECE |

| CAROM | | | | | |
|-------|------------|---------------------|--------|----------|--------|
| SLNO | USN | NAME OF THE STUDENT | GENDER | YEAR | BRANCH |
| 1 | 1SV16EC414 | SOWNDARYA A | F | IV YEAR | ECE |
| 2 | 1SV15EC027 | NOOR AYESHA | F | III YEAR | ECE |

| CHESS | | | | | |
|-------|------------|-------------------------|--------|---------|--------|
| SLNO | USN | NAME OF THE STUDENT | GENDER | YEAR | BRANCH |
| 1 | 1SV15EC047 | THOSHITHA | F | IV YEAR | ECE |
| 2 | 1SV15EC014 | GEETA RAMESHAPPA HANCHI | F | IV YEAR | ECE |

| TABLE TENNIS | | | | | |
|--------------|------------|---------------------|--------|---------|--------|
| SLNO | USN | NAME OF THE STUDENT | GENDER | YEAR | BRANCH |
| 1 | 1SV18EC403 | NIROSHA M V | F | II YEAR | ECE |
| 2 | 1SV14EC015 | LAHARI N RAJ | F | IV YEAR | ECE |

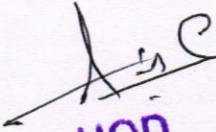
HOD
Dept of E&C
SIET, Tumkur-6



Shridevi Institute of Engineering and Technology,
Tumkur - 572106



DEPARTMENT OF ELECTRICAL & ELECTRONICS ENGINEERING

Date: 01-12-2018

It is here by sending list of students participating in Annual Inter department sports activities for the following events

| | | | |
|---------------------|-------------|------------|----------|
| 1. Throw Ball | : Monday | 03-12-2018 | 11.30 AM |
| 2. Volley Ball | : Tuesday | 04-12-2018 | 2.30 PM |
| 3. Kho Kho | : Thursday | 06-12-2018 | 2.30 PM |
| 4. Cricket | : Friday | 07-12-2018 | 2.30 PM |
| 5. Ball Badminton | : Monday | 10-12-2018 | 2.30 PM |
| 6. Kabaddi | : Monday | 10-12-2018 | 2.30 PM |
| 7. Shatal Badminton | : Tuesday | 11-12-2018 | 2.30 PM |
| 8. Basketball | : Wednesday | 12-12-2018 | 2.30 PM |
| 9. Carom | : Thursday | 13-12-2018 | 2.30 PM |
| 10. Chess | : Thursday | 13-12-2018 | 2.30 PM |
| 11. Table Tennis | : Friday | 14-12-2018 | 2.30 PM |
| 12. Gim | : Saturday | 15-12-2018 | 10.30 AM |
| 13. Hand ball | : Monday | 17-12-2018 | 11.30 AM |
| 14. Foot Ball | : Tuesday | 18-12-2018 | 2.30 PM |

Clue

Sports Coordinator

G. H. Ramu

Head of the Department

Head of the Department
Electrical & Electronics Engineering
Shridevi Institute of Engineering & Technology
TUMKUR-572106.

**LIST OF STUDENTS PARTICIPATING IN ANNUAL INTERDEPARTMENTAL
ANNUAL SPORTS ACTIVITY 2019-20**

EE

| Volley Ball | | | | | |
|-------------|------------|---------------------|--------|----------|--------|
| Sl.No | USN | Name of the Student | Gender | Year | Branch |
| 1 | 1SV18EE002 | AMOGHAVARSHA M | M | II YEAR | EE |
| 2 | 1SV18EE003 | GAVISIDDAPPA | M | II YEAR | EE |
| 3 | 1SV18EE004 | MOHAMMEDFAKRUDDIN | M | II YEAR | EE |
| 4 | 1SV18EE005 | MOHAMMED LUQMAAN | M | II YEAR | EE |
| 5 | 1SV17EE002 | GANESH KUMAR | M | III YEAR | EE |
| 6 | 1SV17EE004 | MAHESH | M | III YEAR | EE |
| 7 | 1SV17EE010 | SACHIN KUMAR | M | III YEAR | EE |
| 8 | 1SV15EE016 | DILEEP KUMAR B T | M | IV YEAR | EE |
| 9 | 1SV14EE001 | AKSHAYKUMAR GK | M | IV YEAR | EE |
| 10 | 1SV15EE001 | ABHISHEK L S | M | IV YEAR | EE |
| 11 | 1SV15EE011 | CHANDANKUMAR H S | M | IV YEAR | EE |
| 12 | 1SV15EE014 | CHIDAMBAR PAWADADA | M | IV YEAR | EE |

| Kho-Kho | | | | | |
|---------|------------|----------------------------|--------|----------|--------|
| Sl.No | USN | Name of the Student | Gender | Year | Branch |
| 1 | 1SV18EE004 | MOHAMMEDFAKRUDDIN | M | II YEAR | EE |
| 2 | 1SV18EE005 | MOHAMMED LUQMAAN | M | II YEAR | EE |
| 3 | 1SV18EE006 | NETHRANANDA K N | M | II YEAR | EE |
| 4 | 1SV18EE007 | PREETHAM M | M | II YEAR | EE |
| 5 | 1SV19EE405 | VIJAY M S | M | II YEAR | EE |
| 6 | 1SV17EE002 | GANESH KUMAR | M | III YEAR | EE |
| 7 | 1SV17EE004 | MAHESH | M | III YEAR | EE |
| 8 | 1SV18EE402 | MOHEMMED OWAIZ FATHAI | M | III YEAR | EE |
| 9 | 1SV15EE014 | CHIDAMBAR PAWADADA | M | IV YEAR | EE |
| 10 | 1SV15EE016 | DILEEP KUMAR B T | M | IV YEAR | EE |
| 11 | 1SV15EE022 | KUMAR PARAMESHWAR HEGDE | M | IV YEAR | EE |
| 12 | 1SV15EE023 | MANIKIRAN K R | M | IV YEAR | EE |

| Ball Batminton | | | | | |
|----------------|------------|-----------------------|--------|----------|--------|
| Sl.No | USN | Name of the Student | Gender | Year | Branch |
| 1 | 1SV19EE402 | RUDRESH B J | M | II YEAR | EE |
| 2 | 1SV19EE403 | SHARATH H M | M | II YEAR | EE |
| 3 | 1SV19EE404 | TEJAMRUTHA BINDU N V | M | II YEAR | EE |
| 4 | 1SV18EE012 | SUBIN S JOHN | M | II YEAR | EE |
| 5 | 1SV19EE401 | RAVIBABU M | M | II YEAR | EE |
| 6 | 1SV19EE402 | RUDRESH B J | M | II YEAR | EE |
| 7 | 1SV19EE403 | SHARATH H M | M | II YEAR | EE |
| 8 | 1SV19EE405 | VIJAY M S | M | II YEAR | EE |
| 9 | 1SV18EE402 | MOHEMMED OWAIZ FATHAI | M | III YEAR | EE |
| 10 | 1SV15EE030 | SHAMSHIR ANSARI | M | IV YEAR | EE |

| Kabaddi | | | | | |
|---------|------------|-----------------------|--------|----------|--------|
| Sl.No | USN | Name of the Student | Gender | Year | Branch |
| 1 | 1SV18EE008 | RAKESH S | M | II YEAR | EE |
| 2 | 1SV18EE009 | S DON BENIN JOSES | M | II YEAR | EE |
| 3 | 1SV18EE012 | SUBIN S JOHN | M | II YEAR | EE |
| 4 | 1SV19EE401 | RAVIBABU M | M | II YEAR | EE |
| 5 | 1SV17EE004 | MAHESH | M | III YEAR | EE |
| 6 | 1SV17EE010 | SACHIN KUMAR | M | III YEAR | EE |
| 7 | 1SV18EE402 | MOHEMMED OWAIZ FATHAI | M | III YEAR | EE |

| | | | | | |
|----|------------|----------------------------|---|---------|----|
| 8 | 1SV14EE001 | AKSHAYKUMAR GK | M | IV YEAR | EE |
| 9 | 1SV15EE016 | DILEEP KUMAR B T | M | IV YEAR | EE |
| 10 | 1SV15EE022 | KUMAR PARAMESHWAR HEGDE | M | IV YEAR | EE |
| 11 | 1SV15EE023 | MANIKIRAN K R | M | IV YEAR | EE |
| 12 | 1SV15EE030 | SHAMSHIR ANSARI | M | IV YEAR | EE |

| Shatal Badminton | | | | | |
|------------------|------------|-----------------------|--------|----------|--------|
| Sl.No | USN | Name of the Student | Gender | Year | Branch |
| 1 | 1SV19EE403 | SHARATH H M | M | II YEAR | EE |
| 2 | 1SV19EE404 | TEJAMRUTHA BINDU N V | M | II YEAR | EE |
| 3 | 1SV19EE405 | VIJAY M S | M | II YEAR | EE |
| 4 | 1SV18EE402 | MOHEMMED OWAIZ FATHAI | M | III YEAR | EE |
| 5 | 1SV14EE001 | AKSHAYKUMAR GK | M | IV YEAR | EE |

| Basket Ball | | | | | |
|-------------|------------|----------------------------|--------|----------|--------|
| Sl.No | USN | Name of the Student | Gender | Year | Branch |
| 1 | 1SV19EE402 | RUDRESH B J | M | II YEAR | EE |
| 2 | 1SV19EE403 | SHARATH H M | M | II YEAR | EE |
| 3 | 1SV19EE404 | TEJAMRUTHA BINDU N V | M | II YEAR | EE |
| 4 | 1SV17EE004 | MAHESH | M | III YEAR | EE |
| 5 | 1SV17EE010 | SACHIN KUMAR | M | III YEAR | EE |
| 6 | 1SV17EE004 | MAHESH | M | III YEAR | EE |
| 7 | 1SV18EE402 | MOHEMMED OWAIZ FATHAI | M | III YEAR | EE |
| 8 | 1SV15EE022 | KUMAR PARAMESHWAR HEGDE | M | IV YEAR | EE |
| 9 | 1SV15EE023 | MANIKIRAN K R | M | IV YEAR | EE |
| 10 | 1SV15EE030 | SHAMSHIR ANSARI | M | IV YEAR | EE |

| Carom | | | | | |
|-------|------------|----------------------|--------|---------|--------|
| Sl.No | USN | Name of the Student | Gender | Year | Branch |
| 1 | 1SV19EE404 | TEJAMRUTHA BINDU N V | M | II YEAR | EE |
| 2 | 1SV15EE030 | SHAMSHIR ANSARI | M | IV YEAR | EE |

| Chess | | | | | |
|-------|------------|---------------------|--------|----------|--------|
| Sl.No | USN | Name of the Student | Gender | Year | Branch |
| 1 | 1SV17EE004 | MAHESH | M | III YEAR | EE |
| 2 | 1SV14EE001 | AKSHAYKUMAR GK | M | IV YEAR | EE |

| Table Tennis | | | | | |
|--------------|------------|---------------------|--------|----------|--------|
| Sl.No | USN | Name of the Student | Gender | Year | Branch |
| 1 | 1SV18EE007 | PREETHAM M | M | II YEAR | EE |
| 2 | 1SV17EE010 | SACHIN KUMAR | M | III YEAR | EE |

| Hand Ball | | | | | |
|-----------|------------|-----------------------|--------|----------|--------|
| Sl.No | USN | Name of the Student | Gender | Year | Branch |
| 1 | 1SV18EE006 | NETHRANANDA K N | M | II YEAR | EE |
| 2 | 1SV18EE007 | PREETHAM M | M | II YEAR | EE |
| 3 | 1SV18EE008 | RAKESH S | M | II YEAR | EE |
| 4 | 1SV18EE009 | S DON BENIN JOSES | M | II YEAR | EE |
| 5 | 1SV17EE002 | GANESH KUMAR | M | III YEAR | EE |
| 6 | 1SV17EE004 | MAHESH | M | III YEAR | EE |
| 7 | 1SV17EE010 | SACHIN KUMAR | M | III YEAR | EE |
| 8 | 1SV18EE402 | MOHEMMED OWAIZ FATHAI | M | III YEAR | EE |
| 9 | 1SV15EE011 | CHANDANKUMAR H S | M | IV YEAR | EE |

| | | | | | |
|----|------------|--------------------|---|---------|----|
| 10 | 1SV15EE014 | CHIDAMBAR PAWADADA | M | IV YEAR | EE |
| 11 | 1SV15EE016 | DILEEP KUMAR B T | M | IV YEAR | EE |

| Foot Ball | | | | | |
|-----------|------------|-----------------------|--------|----------|--------|
| Sl.No | USN | Name of the Student | Gender | Year | Branch |
| 1 | 1SV18EE002 | AMOGHAVARSHA M | M | II YEAR | EE |
| 2 | 1SV18EE003 | GAVISIDDAPPA | M | II YEAR | EE |
| 3 | 1SV18EE004 | MOHAMMEDFAKRUDDIN | M | II YEAR | EE |
| 4 | 1SV18EE005 | MOHAMMED LUQMAAN | M | II YEAR | EE |
| 5 | 1SV19EE403 | SHARATH H M | M | II YEAR | EE |
| 6 | 1SV19EE404 | TEJAMRUTHA BINDU N V | M | II YEAR | EE |
| 7 | 1SV19EE405 | VIJAY M S | M | II YEAR | EE |
| 8 | 1SV17EE002 | GANESH KUMAR | M | III YEAR | EE |
| 9 | 1SV17EE010 | SACHIN KUMAR | M | III YEAR | EE |
| 10 | 1SV18EE402 | MOHEMMED OWAIZ FATHAI | M | III YEAR | EE |
| 11 | 1SV14EE001 | AKSHAYKUMAR GK | M | IV YEAR | EE |
| 12 | 1SV15EE001 | ABHISHEK L S | M | IV YEAR | EE |
| 13 | 1SV15EE011 | CHANDANKUMAR H S | M | IV YEAR | EE |
| 14 | 1SV15EE014 | CHIDAMBAR PAWADADA | M | IV YEAR | EE |
| 15 | 1SV15EE016 | DILEEP KUMAR B T | M | IV YEAR | EE |
| 16 | 1SV15EE030 | SHAMSHIR ANSARI | M | IV YEAR | EE |

| Throw Ball | | | | | |
|------------|------------|---------------------|--------|----------|--------|
| Sl.No | USN | Name of the Student | Gender | Year | Branch |
| 1 | 1SV17EE006 | NETHRAVATHI S M | F | II YEAR | EE |
| 2 | 1SV17EE012 | SUPRIYA A | F | II YEAR | EE |
| 3 | 1SV18EE011 | SHOBHASHREE S | F | II YEAR | EE |
| 4 | 1SV19EE400 | MEGHANA T C | F | II YEAR | EE |
| 5 | 1SV17EE005 | MEGHA N | F | III YEAR | EE |
| 6 | 1SV17EE009 | RAMYA S | F | III YEAR | EE |
| 7 | 1SV18EE403 | POOJA B N | F | III YEAR | EE |
| 8 | 1SV14EE004 | BHAVYA SHREE N | F | IV YEAR | EE |
| 9 | 1SV15EE004 | AMRUTHA | F | IV YEAR | EE |
| 10 | 1SV15EE010 | CHAITHRA C | F | IV YEAR | EE |
| 11 | 1SV15EE039 | Y T PRIYA | F | IV YEAR | EE |

| Kho-Kho | | | | | |
|---------|------------|---------------------|--------|----------|--------|
| Sl.No | USN | Name of the Student | Gender | Year | Branch |
| 1 | 1SV17EE006 | NETHRAVATHI S M | F | II YEAR | EE |
| 2 | 1SV17EE012 | SUPRIYA A | F | II YEAR | EE |
| 3 | 1SV18EE011 | SHOBHASHREE S | F | II YEAR | EE |
| 4 | 1SV19EE400 | MEGHANA T C | F | II YEAR | EE |
| 5 | 1SV17EE005 | MEGHA N | F | III YEAR | EE |
| 6 | 1SV17EE009 | RAMYA S | F | III YEAR | EE |
| 7 | 1SV18EE403 | POOJA B N | F | III YEAR | EE |
| 8 | 1SV14EE004 | BHAVYA SHREE N | F | IV YEAR | EE |
| 9 | 1SV15EE004 | AMRUTHA | F | IV YEAR | EE |
| 10 | 1SV15EE010 | CHAITHRA C | F | IV YEAR | EE |
| 11 | 1SV15EE039 | Y T PRIYA | F | IV YEAR | EE |

| Ball Badminton | | | | | |
|----------------|------------|---------------------|--------|----------|--------|
| Sl.No | USN | Name of the Student | Gender | Year | Branch |
| 1 | 1SV17EE012 | SUPRIYA A | F | II YEAR | EE |
| 2 | 1SV18EE011 | SHOBHASHREE S | F | II YEAR | EE |
| 3 | 1SV19EE400 | MEGHANA T C | F | II YEAR | EE |
| 4 | 1SV17EE005 | MEGHA N | F | III YEAR | EE |
| 5 | 1SV17EE009 | RAMYA S | F | III YEAR | EE |
| 6 | 1SV18EE403 | POOJA B N | F | III YEAR | EE |
| 7 | 1SV14EE004 | BHAVYA SHREE N | F | IV YEAR | EE |
| 8 | 1SV15EE004 | AMRUTHA | F | IV YEAR | EE |
| 9 | 1SV15EE010 | CHAITHRA C | F | IV YEAR | EE |
| 10 | 1SV15EE039 | Y T PRIYA | F | IV YEAR | EE |

| Shatal Badminton | | | | | |
|------------------|------------|---------------------|--------|----------|--------|
| Sl.No | USN | Name of the Student | Gender | Year | Branch |
| 1 | 1SV19EE400 | MEGHANA T C | F | II YEAR | EE |
| 2 | 1SV17EE005 | MEGHA N | F | III YEAR | EE |
| 3 | 1SV17EE009 | RAMYA S | F | III YEAR | EE |
| 4 | 1SV18EE403 | POOJA B N | F | III YEAR | EE |
| 5 | 1SV14EE004 | BHAVYA SHREE N | F | IV YEAR | EE |

| Carom | | | | | |
|-------|------------|---------------------|--------|----------|--------|
| Sl.No | USN | Name of the Student | Gender | Year | Branch |
| 1 | 1SV17EE006 | NETHRAVATHI S M | F | II YEAR | EE |
| 2 | 1SV17EE009 | RAMYA S | F | III YEAR | EE |

| Chess | | | | | |
|-------|------------|---------------------|--------|---------|--------|
| Sl.No | USN | Name of the Student | Gender | Year | Branch |
| 1 | 1SV18EE011 | SHOBHASHREE S | F | II YEAR | EE |
| 2 | 1SV15EE039 | Y T PRIYA | F | IV YEAR | EE |

| Table Tennis | | | | | |
|--------------|------------|---------------------|--------|----------|--------|
| Sl.No | USN | Name of the Student | Gender | Year | Branch |
| 1 | 1SV17EE005 | MEGHA N | F | III YEAR | EE |
| 2 | 1SV15EE004 | AMRUTHA | F | IV YEAR | EE |

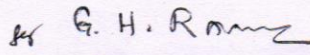
 Head of the Department
 Electrical & Electronics Engineering
 Shridevi Institute of Engineering & Technology
 TUMKUR-572106.



Shridevi Institute of Engineering and Technology,
Tumkur - 572106



DEPARTMENT OF FIRST YEAR UG STUDIES

Date: 01-12-2018

It is here by sending list of students participating in Annual Inter department sports activities for the following events

- | | | | |
|---------------------|-------------|------------|----------|
| 1. Throw Ball | : Monday | 03-12-2018 | 11.30 AM |
| 2. Volley Ball | : Tuesday | 04-12-2018 | 2.30 PM |
| 3. Kho Kho | : Thursday | 06-12-2018 | 2.30 PM |
| 4. Cricket | : Friday | 07-12-2018 | 2.30 PM |
| 5. Ball Badminton | : Monday | 10-12-2018 | 2.30 PM |
| 6. Kabaddi | : Monday | 10-12-2018 | 2.30 PM |
| 7. Shatal Badminton | : Tuesday | 11-12-2018 | 2.30 PM |
| 8. Basketball | : Wednesday | 12-12-2018 | 2.30 PM |
| 9. Carom | : Thursday | 13-12-2018 | 2.30 PM |
| 10. Chess | : Thursday | 13-12-2018 | 2.30 PM |
| 11. Table Tennis | : Friday | 14-12-2018 | 2.30 PM |
| 12. Gim | : Saturday | 15-12-2018 | 10.30 AM |
| 13. Hand ball | : Monday | 17-12-2018 | 11.30 AM |
| 14. Foot Ball | : Tuesday | 18-12-2018 | 2.30 PM |

Sports Coordinator

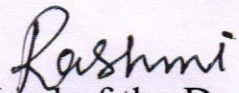
Head of the Department

**LIST OF STUDENTS PARTICIPATING IN ANNUAL INTERDEPARTMENTAL
ANNUAL SPORTS ACTIVITY 2018-19
1 YEAR**

| THROW BALL | | | | | |
|------------|------------|--------------------------|--------|--------|--------|
| SLNO | USN | NAME OF THE STUDENT | GENDER | YEAR | BRANCH |
| 1 | 1SV18CS006 | BHARATH KUMAR J | M | I YEAR | CSE |
| 2 | 1SV18CS022 | KUSHAL KUMAR D | M | I YEAR | CSE |
| 3 | 1SV18CS025 | MANORANJAN P M | M | I YEAR | CSE |
| 4 | 1SV18CS046 | VIVEKANAND MATH | M | I YEAR | CSE |
| 5 | 1SV18EC016 | PRASHANTH M | M | I YEAR | ECE |
| 6 | 1SV18EC017 | PREMKUMAR | M | I YEAR | ECE |
| 7 | 1SV18EC020 | SAMEER BICHAGATTI | M | I YEAR | ECE |
| 8 | 1SV18EE013 | VISHAL D SOUZA | M | I YEAR | EEE |
| 9 | 1SV18ME009 | ROUSHAN ALI KHAN | M | I YEAR | ME |
| 10 | 1SV18CV032 | SHIVA SHANKARA. C. S. | M | I YEAR | CV |
| 11 | 1SV18CV008 | CHANDRAHASA PATEL. K. A. | M | I YEAR | CV |
| 12 | 1SV18CV025 | PAUL. RANADIVE. | M | I YEAR | CV |

| VOLLEY BALL | | | | | |
|-------------|------------|-----------------------------|--------|--------|--------|
| SLNO | USN | NAME OF THE STUDENT | GENDER | YEAR | BRANCH |
| 1 | 1SV18CS032 | PRAJWAL C | M | I YEAR | CSE |
| 2 | 1SV18CS035 | SANDEEP H | M | I YEAR | CSE |
| 3 | 1SV18EC004 | BASAVARAJ | M | I YEAR | ECE |
| 4 | 1SV18EC009 | GURANNAGOUDA | M | I YEAR | ECE |
| 5 | 1SV18EC010 | KETANRAJ S | M | I YEAR | ECE |
| 6 | 1SV18EE005 | MOHAMMED LUQMAAN | M | I YEAR | EEE |
| 7 | 1SV18EE006 | NETHRANANDA K N | M | I YEAR | EEE |
| 8 | 1SV18ME009 | ROUSHAN ALI KHAN | M | I YEAR | ME |
| 9 | 1SV18ME002 | BHARATH N M | M | I YEAR | ME |
| 10 | 1SV18CV014 | HABIB ULLA KHAN. | M | I YEAR | CV |
| 11 | 1SV18CV026 | PAVAN NAG. M. A. | M | I YEAR | CV |
| 12 | 1SV18CV037 | VITTAL. R. HANAMANNAVAR. | M | I YEAR | CV |

| KHO KHO | | | | | |
|---------|------------|-----------------------------|--------|--------|--------|
| SLNO | USN | NAME OF THE STUDENT | GENDER | YEAR | BRANCH |
| 1 | 1SV18ME005 | MOHAMED ROSHAN D | M | I YEAR | ME |
| 2 | 1SV18ME010 | S PAVAN KUMAR | M | I YEAR | ME |
| 3 | 1SV18EE009 | S DON BENIN JOSES | M | I YEAR | EEE |
| 4 | 1SV18EC004 | BASAVARAJ | M | I YEAR | ECE |
| 5 | 1SV18EC016 | PRASHANTH M | M | I YEAR | ECE |
| 6 | 1SV18CS022 | KUSHAL KUMAR D | M | I YEAR | CSE |
| 7 | 1SV18CS025 | MANORANJAN P M | M | I YEAR | CSE |
| 8 | 1SV18CS004 | AYUSH RANJAN TIWARI | M | I YEAR | CSE |
| 9 | 1SV18ME008 | RANGANATH K M | M | I YEAR | ME |
| 10 | 1SV18ME004 | KIRTHEESH R | M | I YEAR | ME |
| 11 | 1SV18CV007 | CHANDAN GOWDA. P. | M | I YEAR | CV |
| 12 | 1SV18CV037 | VITTAL. R. HANAMANNAVAR. | M | I YEAR | CV |

| CRICKET | | | | | |
|---------|------------|---------------------|--------|--------|--------|
| SLNO | USN | NAME OF THE STUDENT | GENDER | YEAR | BRANCH |
| 1 | 1SV18CV019 | KARTHIK. G. | M | I YEAR | CV |
| 2 | 1SV18CV014 | HABIB ULLA KHAN. | M | I YEAR | CV |
| 3 | 1SV18CV026 | PAVAN NAG. M. A. | M | I YEAR | CV |

| | | | | | |
|----|------------|----------------------|---|--------|-----|
| 4 | 1SV18CV029 | ROSHAN MAHATO SINGH. | M | I YEAR | CV |
| 5 | 1SV18ME004 | KIRTHEESH R | M | I YEAR | ME |
| 6 | 1SV18ME012 | VENUGOPAL S V | M | I YEAR | ME |
| 7 | 1SV18EE006 | NETHRANANDA K N | M | I YEAR | EEE |
| 8 | 1SV18EE007 | PREETHAM M | M | I YEAR | EEE |
| 9 | 1SV18EE001 | ABHISHEK G M | M | I YEAR | EEE |
| 10 | 1SV18EE002 | AMOGHAVARSHA M | M | I YEAR | EEE |
| 11 | 1SV18CS047 | YASHVANTHKUMAR P | M | I YEAR | CSE |
| 12 | 1SV18EC001 | ANIKET ASHOK NEJE | M | I YEAR | ECE |
| 13 | 1SV18CS022 | KUSHAL KUMAR D | M | I YEAR | CSE |
| 14 | 1SV18CS018 | GURUPRASAD B S | M | I YEAR | CSE |
| 15 | 1SV18CS019 | HADA AMAL KHAN | M | I YEAR | CSE |

| BALL BADMINTON | | | | | |
|----------------|------------|-----------------------------|--------|--------|--------|
| SLNO | USN | NAME OF THE STUDENT | GENDER | YEAR | BRANCH |
| 1 | 1SV18CS004 | AYUSH RANJAN TIWARI | M | I YEAR | CSE |
| 2 | 1SV18EC020 | SAMEER BICHAGATTI | M | I YEAR | ECE |
| 3 | 1SV18EE009 | S DON BENIN JOSES | M | I YEAR | EEE |
| 4 | 1SV18ME008 | RANGANATH K M | M | I YEAR | ME |
| 5 | 1SV18CV013 | DODDANAGOUDA POLICE PATIL. | M | I YEAR | CV |
| 6 | 1SV18CV014 | HABIB ULLA KHAN. | M | I YEAR | CV |
| 7 | 1SV18CV036 | VISHWANATHA. H. P. | M | I YEAR | CV |
| 8 | 1SV18CV037 | VITTAL. R. HANAMANNAVAR. | M | I YEAR | CV |
| 9 | 1SV18EE013 | VISHAL D SOUZA | M | I YEAR | EEE |
| 10 | 1SV18ME009 | ROUSHAN ALI KHAN | M | I YEAR | ME |

| KABADDI | | | | | |
|---------|------------|----------------------|--------|--------|--------|
| SLNO | USN | NAME OF THE STUDENT | GENDER | YEAR | BRANCH |
| 1 | 1SV18EC023 | SRINIVAS C | M | I YEAR | ECE |
| 2 | 1SV18EE001 | ABHISHEK G M | M | I YEAR | EEE |
| 3 | 1SV18CS025 | MANORANJAN P M | M | I YEAR | CSE |
| 4 | 1SV18CS037 | SHASHI BHUSHAN KUMAR | M | I YEAR | CSE |
| 5 | 1SV18EC020 | SAMEER BICHAGATTI | M | I YEAR | ECE |
| 6 | 1SV18EE007 | PREETHAM M | M | I YEAR | EEE |
| 7 | 1SV18ME011 | SAGAR DASIKOP | M | I YEAR | ME |
| 8 | 1SV18CV001 | AKARSH CHANDRAKANTH. | M | I YEAR | CV |
| 9 | 1SV18CV017 | HRUTHVIK. P. | M | I YEAR | CV |
| 10 | 1SV18CV034 | SURYA KIRAN. M. D. | M | I YEAR | CV |
| 11 | 1SV18ME005 | MOHAMED ROSHAN D | M | I YEAR | ME |
| 12 | 1SV18ME002 | BHARATH N M | M | I YEAR | ME |

| SHATAL BADMINTON | | | | | |
|------------------|------------|-----------------------|--------|--------|--------|
| SLNO | USN | NAME OF THE STUDENT | GENDER | YEAR | BRANCH |
| 1 | 1SV18EE013 | VISHAL D SOUZA | M | I YEAR | EEE |
| 2 | 1SV18ME009 | ROUSHAN ALI KHAN | M | I YEAR | ME |
| 3 | 1SV18CS047 | YASHVANTHKUMAR P | M | I YEAR | CSE |
| 4 | 1SV18CV032 | SHIVA SHANKARA. C. S. | M | I YEAR | CV |
| 5 | 1SV18EC012 | MOUNESHGOWDA | M | I YEAR | ECE |

| BASKET BALL | | | | | |
|-------------|------------|---------------------|--------|--------|--------|
| SLNO | USN | NAME OF THE STUDENT | GENDER | YEAR | BRANCH |
| 1 | 1SV18CS030 | PAVAN C DURGAD | M | I YEAR | CSE |
| 2 | 1SV18CS017 | GANYA KUMAR G R | M | I YEAR | CSE |
| 3 | 1SV18CS004 | AYUSH RANJAN TIWARI | M | I YEAR | CSE |

| | | | | | |
|----|------------|----------------------|---|--------|-----|
| 4 | 1SV18EC023 | SRINIVAS C | M | I YEAR | ECE |
| 5 | 1SV18EE001 | ABHISHEK G M | M | I YEAR | EEE |
| 6 | 1SV18EC016 | PRASHANTH M | M | I YEAR | ECE |
| 7 | 1SV18EE012 | SUBIN S JOHN | M | I YEAR | EEE |
| 8 | 1SV18EE013 | VISHAL D SOUZA | M | I YEAR | EEE |
| 9 | 1SV18ME011 | SAGAR DASIKOP | M | I YEAR | ME |
| 10 | 1SV18CV001 | AKARSH CHANDRAKANTH. | M | I YEAR | CV |

| CAROM | | | | | |
|-------|------------|----------------------|--------|--------|--------|
| SLNO | USN | NAME OF THE STUDENT | GENDER | YEAR | BRANCH |
| 1 | 1SV18CV001 | AKARSH CHANDRAKANTH. | M | I YEAR | CV |
| 2 | 1SV18CS004 | AYUSH RANJAN TIWARI | M | I YEAR | CSE |

| CHESS | | | | | |
|-------|------------|---------------------|--------|--------|--------|
| SLNO | USN | NAME OF THE STUDENT | GENDER | YEAR | BRANCH |
| 1 | 1SV18ME009 | ROUSHAN ALI KHAN | M | I YEAR | ME |
| 2 | 1SV18EE006 | NETHRANANDA K N | M | I YEAR | EEE |

| TABLE TENNIS | | | | | |
|--------------|------------|---------------------|--------|--------|--------|
| SLNO | USN | NAME OF THE STUDENT | GENDER | YEAR | BRANCH |
| 1 | 1SV18EC012 | MOUNESHGOWDA | M | I YEAR | ECE |
| 2 | 1SV18CS011 | DHARMANA HARIKA | M | I YEAR | CSE |

| FOOT BALL | | | | | |
|-----------|------------|-----------------------------|--------|--------|--------|
| SLNO | USN | NAME OF THE STUDENT | GENDER | YEAR | BRANCH |
| 1 | 1SV18CV013 | DODDANAGOUDA POLICE PATIL. | M | I YEAR | CV |
| 2 | 1SV18CV014 | HABIB ULLA KHAN. | M | I YEAR | CV |
| 3 | 1SV18CV037 | VITTAL. R. HANAMANNAVAR. | M | I YEAR | CV |
| 4 | 1SV18ME001 | ASHOKKUMAR S S | M | I YEAR | ME |
| 5 | 1SV18ME005 | MOHAMED ROSHAN D | M | I YEAR | ME |
| 6 | 1SV18EE007 | PREETHAM M | M | I YEAR | EEE |
| 7 | 1SV18EE002 | AMOGHAVARSHA M | M | I YEAR | EEE |
| 8 | 1SV18EE004 | MOHAMMEDFAKRUDDIN | M | I YEAR | EEE |
| 9 | 1SV18EC012 | MOUNESHGOWDA | M | I YEAR | ECE |
| 10 | 1SV18CS047 | YASHVANTHKUMAR P | M | I YEAR | CSE |
| 11 | 1SV18EC016 | PRASHANTH M | M | I YEAR | ECE |
| 12 | 1SV18EC009 | GURANNAGOUDA | M | I YEAR | ECE |
| 13 | 1SV18CS019 | HADA AMAL KHAN | M | I YEAR | CSE |
| 14 | 1SV18CS021 | KEERTHIPRASAD B K | M | I YEAR | CSE |
| 15 | 1SV18CS037 | SHASHI BHUSHAN KUMAR | M | I YEAR | CSE |
| 16 | 1SV18CS004 | AYUSH RANJAN TIWARI | M | I YEAR | CSE |

| THROW BALL | | | | | |
|------------|------------|---------------------|--------|---------|--------|
| SLNO | USN | NAME OF THE STUDENT | GENDER | YEAR | BRANCH |
| 1 | 1SV18MBA15 | MANJUSHREE. B. G. | F | I YEAR | MBA |
| 2 | 1SV18MBA21 | POOJA. C. | F | I YEAR | MBA |
| 3 | 1SV18MBA22 | PRIYANKA KUMARI. | F | I YEAR | MBA |
| 4 | 1SV18MBA25 | RUMANA KHANUM | F | I YEAR | MBA |
| 5 | 1SV17MBA06 | CHAITHRA H R | F | II YEAR | MBA |
| 6 | 1SV17MBA08 | GOWRAMMA G S | F | II YEAR | MBA |
| 7 | 1SV17MBA09 | HELEN SUPRIYA S | F | II YEAR | MBA |
| 8 | 1SV17MBA10 | KALPANA A | F | II YEAR | MBA |
| 9 | 1SV17MBA12 | KUBRA FATHIMA | F | II YEAR | MBA |
| 10 | 1SV17MBA13 | KUMARI SHANTI USHA | F | II YEAR | MBA |
| 11 | 1SV17MBA16 | MANJUSHREE M | F | II YEAR | MBA |
| 12 | 1SV17MBA22 | POORNIMA A S | F | II YEAR | MBA |

| KHO KHO | | | | | |
|---------|------------|----------------------|--------|--------|--------|
| SLNO | USN | NAME OF THE STUDENT | GENDER | YEAR | BRANCH |
| 1 | 1SV18CS020 | HARSHITHA S | F | I YEAR | CSE |
| 2 | 1SV18CS023 | LAVANYA T A | F | I YEAR | CSE |
| 3 | 1SV18CS024 | LISHA SHREE NAYAKA S | F | I YEAR | CSE |
| 4 | 1SV18CS044 | UMME HANNE | F | I YEAR | CSE |
| 5 | 1SV18CS045 | VIJAYALAXMI | F | I YEAR | CSE |
| 6 | 1SV18EC002 | ANUSHA G S | F | I YEAR | ECE |
| 7 | 1SV18EC005 | BHARATHI M | F | I YEAR | ECE |
| 8 | 1SV18EE011 | SHOBHASHREE S | F | I YEAR | EEE |
| 9 | 1SV18CV012 | DEVIKA. K. PATIL. | F | I YEAR | CV |
| 10 | 1SV18CV018 | JAYASHREE. P. | F | I YEAR | CV |
| 11 | 1SV18CV020 | KAVYA. B. K. | F | I YEAR | CV |
| 12 | 1SV18CV023 | NAGALAKSHMI. | F | I YEAR | CV |

| BALL BADMINTON | | | | | |
|----------------|------------|---------------------|--------|--------|--------|
| SLNO | USN | NAME OF THE STUDENT | GENDER | YEAR | BRANCH |
| 1 | 1SV18CS014 | ENCHARA M | F | I YEAR | CSE |
| 2 | 1SV18CS015 | GAGANA N | F | I YEAR | CSE |
| 3 | 1SV18CS020 | HARSHITHA S | F | I YEAR | CSE |
| 4 | 1SV18CS033 | PRIYADARSHINI R | F | I YEAR | CSE |
| 5 | 1SV18CS034 | RAKSHITHA RANGANATH | F | I YEAR | CSE |
| 6 | 1SV18CS038 | SHRADDHA S | F | I YEAR | CSE |
| 7 | 1SV18CS044 | UMME HANNE | F | I YEAR | CSE |
| 8 | 1SV18CS045 | VIJAYALAXMI | F | I YEAR | CSE |
| 9 | 1SV18EC002 | ANUSHA G S | F | I YEAR | ECE |
| 10 | 1SV18CV012 | DEVIKA. K. PATIL. | F | I YEAR | CV |

| CAROM | | | | | |
|-------|------------|---------------------|--------|--------|--------|
| SLNO | USN | NAME OF THE STUDENT | GENDER | YEAR | BRANCH |
| 1 | 1SV18CV003 | APOORVA. A. | F | I YEAR | CV |
| 2 | 1SV18EC013 | MOUNIKA Y | F | I YEAR | ECE |

| CHESS | | | | | |
|-------|------------|---------------------|--------|--------|--------|
| SLNO | USN | NAME OF THE STUDENT | GENDER | YEAR | BRANCH |
| 1 | 1SV18CS034 | RAKSHITHA RANGANATH | F | I YEAR | CSE |
| 2 | 1SV18EE011 | SHOBHASHREE S | F | I YEAR | EEE |

| TABLE TENNIS | | | | | |
|--------------|------------|---------------------|--------|--------|--------|
| SLNO | USN | NAME OF THE STUDENT | GENDER | YEAR | BRANCH |
| 1 | 1SV18CS031 | PRAGNA H S | F | I YEAR | CSE |
| 2 | 1SV18EC006 | BRUNDA K | F | I YEAR | ECE |

Handwritten signature



DEPARTMENT OF MASTER OF BUSINESS ADMINISTRATION

Date: 01-12-2018

It is here by sending list of students participating in Annual Inter department sports activities for the following events

- | | | | |
|---------------------|-------------|------------|----------|
| 1. Throw Ball | : Monday | 03-12-2018 | 11.30 AM |
| 2. Volley Ball | : Tuesday | 04-12-2018 | 2.30 PM |
| 3. Kho Kho | : Thursday | 06-12-2018 | 2.30 PM |
| 4. Cricket | : Friday | 07-12-2018 | 2.30 PM |
| 5. Ball Badminton | : Monday | 10-12-2018 | 2.30 PM |
| 6. Kabaddi | : Monday | 10-12-2018 | 2.30 PM |
| 7. Shatal Badminton | : Tuesday | 11-12-2018 | 2.30 PM |
| 8. Basketball | : Wednesday | 12-12-2018 | 2.30 PM |
| 9. Carom | : Thursday | 13-12-2018 | 2.30 PM |
| 10. Chess | : Thursday | 13-12-2018 | 2.30 PM |
| 11. Table Tennis | : Friday | 14-12-2018 | 2.30 PM |
| 12. Gim | : Saturday | 15-12-2018 | 10.30 AM |
| 13. Hand ball | : Monday | 17-12-2018 | 11.30 AM |
| 14. Foot Ball | : Tuesday | 18-12-2018 | 2.30 PM |

M. S. S. S.
Sports Coordinator

S. I. E. T.
Head of the Department
M.B.A. Programme
S.I.E.T. Tumkur

**LIST OF STUDENTS PARTICIPATING IN ANNUAL INTERDEPARTMENTAL
ANNUAL SPORTS ACTIVITY 2018-19**

MBA

| THROW BALL | | | | | |
|-------------------|------------|----------------------------------|---------------|-------------|---------------|
| SLNO | USN | NAME OF THE STUDENT | GENDER | YEAR | BRANCH |
| 1 | 1SV18MBA02 | ANANTHU. S. M. | M | I YEAR | MBA |
| 2 | 1SV18MBA03 | B. S. CHETHAN. | M | I YEAR | MBA |
| 3 | 1SV18MBA11 | MADHU SUDHAN. L. | M | I YEAR | MBA |
| 4 | 1SV18MBA06 | JOHNSON SHAJL. | M | I YEAR | MBA |
| 5 | 1SV18MBA07 | JOSEPH ANTONY | M | I YEAR | MBA |
| 6 | 1SV17MBA07 | CLINTON ELIAZER ABRAHAM | M | II YEAR | MBA |
| 7 | 1SV17MBA11 | KOUSHIK KUMAR H P | M | II YEAR | MBA |
| 8 | 1SV17MBA14 | MADHUKAR REDDY S R | M | II YEAR | MBA |
| 9 | 1SV18MMD01 | JAYANTH. C. | M | I YEAR | MMD |
| 10 | 1SV18MMD02 | B. VENKATESHA. | M | I YEAR | MMD |
| 11 | 1SV17SCS03 | TIENKOUA GUELABLIHI MARDOCHEE | M | II YEAR | SCS |
| 12 | 1SV17MBA29 | VEERESHA YADAV M K | M | II YEAR | MBA |

| VOLLEY BALL | | | | | |
|--------------------|------------|----------------------------------|---------------|-------------|---------------|
| SLNO | USN | NAME OF THE STUDENT | GENDER | YEAR | BRANCH |
| 1 | 1SV17MBA21 | PAVAN KUMAR S | M | II YEAR | MBA |
| 2 | 1SV17MBA29 | VEERESHA YADAV M K | M | II YEAR | MBA |
| 3 | 1SV18MMD01 | JAYANTH. C. | M | I YEAR | MMD |
| 4 | 1SV17SCS03 | TIENKOUA GUELABLIHI MARDOCHEE | M | II YEAR | SCS |
| 5 | 1SV17BBT02 | RAJ KUMAR PATEL | M | II YEAR | BBT |
| 6 | 1SV18MBA31 | ARAVIND YARRABAPU. | M | I YEAR | MBA |
| 7 | 1SV17MBA01 | ANIL KUMAR D | M | II YEAR | MBA |
| 8 | 1SV17MBA07 | CLINTON ELIAZER ABRAHAM | M | II YEAR | MBA |
| 9 | 1SV18MBA03 | B. S. CHETHAN. | M | I YEAR | MBA |
| 10 | 1SV18MBA07 | JOSEPH ANTONY | M | I YEAR | MBA |
| 11 | 1SV18MBA11 | MADHU SUDHAN. L. | M | I YEAR | MBA |
| 12 | 1SV18MBA27 | SHARATH KUMARA. G. R. | M | I YEAR | MBA |

| KHO KHO | | | | | |
|----------------|------------|----------------------------|---------------|-------------|---------------|
| SLNO | USN | NAME OF THE STUDENT | GENDER | YEAR | BRANCH |
| 1 | 1SV18MBA20 | NAVEENA. B. L. | M | I YEAR | MBA |
| 2 | 1SV18MBA23 | RAHUL. P. M | M | I YEAR | MBA |
| 3 | 1SV18MBA07 | JOSEPH ANTONY | M | I YEAR | MBA |
| 4 | 1SV18MBA09 | LOHITHA. T. R. | M | I YEAR | MBA |
| 5 | 1SV17MBA07 | CLINTON ELIAZER ABRAHAM | M | II YEAR | MBA |
| 6 | 1SV17MBA11 | KOUSHIK KUMAR H P | M | II YEAR | MBA |
| 7 | 1SV18MBA31 | ARAVIND YARRABAPU. | M | I YEAR | MBA |
| 8 | 1SV17SCS02 | SEHIN GNONEBO RODRIGUE | M | II YEAR | SCS |
| 9 | 1SV18MMD01 | JAYANTH. C. | M | I YEAR | MMD |
| 10 | 1SV18MMD02 | B. VENKATESHA. | M | I YEAR | MMD |
| 11 | 1SV17MBA26 | SAGAR D N | M | II YEAR | MBA |
| 12 | 1SV17MBA29 | VEERESHA YADAV M K | M | II YEAR | MBA |

| CRICKET | | | | | |
|----------------|------------|----------------------------|---------------|-------------|---------------|
| SLNO | USN | NAME OF THE STUDENT | GENDER | YEAR | BRANCH |
| 1 | 1SV18MBA30 | VIDYA. J. KUNNUR. | M | I YEAR | MBA |
| 2 | 1SV18MBA31 | ARAVIND YARRABAPU. | M | I YEAR | MBA |
| 3 | 1SV17MBA01 | ANIL KUMAR D | M | II YEAR | MBA |
| 4 | 1SV17MBA07 | CLINTON ELIAZER ABRAHAM | M | II YEAR | MBA |

| | | | | | |
|----|------------|--------------------|---|---------|-----|
| 5 | 1SV17MBA11 | KOUSHIK KUMAR H P | M | II YEAR | MBA |
| 6 | 1SV17MBA14 | MADHUKAR REDDY S R | M | II YEAR | MBA |
| 7 | 1SV18MBA23 | RAHUL. P. M | M | I YEAR | MBA |
| 8 | 1SV18MBA12 | MAHESHKUMAR. S. | M | I YEAR | MBA |
| 9 | 1SV18MBA07 | JOSEPH ANTONY | M | I YEAR | MBA |
| 10 | 1SV18MBA09 | LOHITHA. T. R. | M | I YEAR | MBA |
| 11 | 1SV18MBA30 | VIDYA. J. KUNNUR. | M | I YEAR | MBA |
| 12 | 1SV18CCS02 | SARVESH MANTHAGOND | M | I YEAR | CCS |
| 13 | 1SV17MBA29 | VEERESHA YADAV M K | M | II YEAR | MBA |
| 14 | 1SV18MMD01 | JAYANTH. C. | M | I YEAR | MMD |
| 15 | 1SV18MBA24 | RANJITHA. K. R. | M | I YEAR | MBA |

| BALL BADMINTON | | | | | |
|----------------|------------|---------------------------|--------|---------|--------|
| SLNO | USN | NAME OF THE STUDENT | GENDER | YEAR | BRANCH |
| 1 | 1SV18MBA11 | MADHU SUDHAN. L. | M | I YEAR | MBA |
| 2 | 1SV18MBA02 | ANANTHU. S. M. | M | I YEAR | MBA |
| 3 | 1SV18MBA04 | GIRISHA.. M. B. | M | I YEAR | MBA |
| 4 | 1SV18MBA06 | JOHNSON SHAJI. | M | I YEAR | MBA |
| 5 | 1SV18MBA28 | SHASHIKUMAR. B. L. | M | I YEAR | MBA |
| 6 | 1SV17MBA23 | PRASANNAKUMAR C | M | II YEAR | MBA |
| 7 | 1SV17MBA25 | RAGAVENDRA N | M | II YEAR | MBA |
| 8 | 1SV17SCS02 | SEHIN GNONEBO RODRIGUE | M | II YEAR | SCS |
| 9 | 1SV18MMD02 | B. VENKATESHA. | M | I YEAR | MMD |
| 10 | 1SV18CCS01 | RAGHAVENDRA TEVARI | M | I YEAR | CCS |

| KABADDI | | | | | |
|---------|------------|----------------------------|--------|---------|--------|
| SLNO | USN | NAME OF THE STUDENT | GENDER | YEAR | BRANCH |
| 1 | 1SV17MBA29 | VEERESHA YADAV M K | M | II YEAR | MBA |
| 2 | 1SV18MMD01 | JAYANTH. C. | M | I YEAR | MMD |
| 3 | 1SV18BBT04 | NAVEEN KUMAR. H. M. | M | I YEAR | BBT |
| 4 | 1SV18CCS01 | RAGHAVENDRA TEVARI | M | I YEAR | CCS |
| 5 | 1SV17MBA07 | CLINTON ELIAZER ABRAHAM | M | II YEAR | MBA |
| 6 | 1SV17MBA11 | KOUSHIK KUMAR H P | M | II YEAR | MBA |
| 7 | 1SV18MBA07 | JOSEPH ANTONY | M | I YEAR | MBA |
| 8 | 1SV18MBA09 | LOHITHA. T. R. | M | I YEAR | MBA |
| 9 | 1SV18MBA20 | NAVEENA. B. L. | M | I YEAR | MBA |
| 10 | 1SV18MBA27 | SHARATH KUMARA. G. R. | M | I YEAR | MBA |
| 11 | 1SV18MBA31 | ARAVIND YARRABAPU. | M | I YEAR | MBA |
| 12 | 1SV18MBA30 | VIDYA. J. KUNNUR. | M | I YEAR | MBA |

| SHATAL BADMINTON | | | | | |
|------------------|------------|---------------------|--------|---------|--------|
| SLNO | USN | NAME OF THE STUDENT | GENDER | YEAR | BRANCH |
| 1 | 1SV18MBA20 | NAVEENA. B. L. | M | I YEAR | MBA |
| 2 | 1SV18MBA23 | RAHUL. P. M | M | I YEAR | MBA |
| 3 | 1SV17MBA11 | KOUSHIK KUMAR H P | M | II YEAR | MBA |
| 4 | 1SV18CCS02 | SARVESH MANTHAGOND | M | I YEAR | CCS |
| 5 | 1SV17MBA14 | MADHUKAR REDDY S R | M | II YEAR | MBA |

| BASKET BALL | | | | | |
|-------------|------------|---------------------|--------|---------|--------|
| SLNO | USN | NAME OF THE STUDENT | GENDER | YEAR | BRANCH |
| 1 | 1SV17MBA26 | SAGAR D N | M | II YEAR | MBA |
| 2 | 1SV17MBA29 | VEERESHA YADAV M K | M | II YEAR | MBA |
| 3 | 1SV18MMD01 | JAYANTH. C. | M | I YEAR | MMD |
| 4 | 1SV18MMD02 | B. VENKATESHA. | M | I YEAR | MMD |
| 5 | 1SV18BBT04 | NAVEEN KUMAR. H. M. | M | I YEAR | BBT |
| 6 | 1SV18CCS01 | RAGHAVENDRA TEVARI | M | I YEAR | CCS |

| | | | | | |
|----|------------|----------------------------------|---|---------|-----|
| 7 | 1SV17SCS03 | TIENKOUA GUELABLIHI MARDOCHEE | M | II YEAR | SCS |
| 8 | 1SV17BBT02 | RAJ KUMAR PATEL | M | II YEAR | BBT |
| 9 | 1SV18MBA04 | GIRISHA.. M. B. | M | I YEAR | MBA |
| 10 | 1SV18MBA06 | JOHNSON SHAJL. | M | I YEAR | MBA |

| CAROM | | | | | |
|-------|------------|---------------------|--------|---------|--------|
| SLNO | USN | NAME OF THE STUDENT | GENDER | YEAR | BRANCH |
| 1 | 1SV18MBA31 | ARAVIND YARRABAPU. | M | I YEAR | MBA |
| 2 | 1SV17MBA23 | PRASANNAKUMAR C | M | II YEAR | MBA |

| CHESS | | | | | |
|-------|------------|----------------------------------|--------|---------|--------|
| SLNO | USN | NAME OF THE STUDENT | GENDER | YEAR | BRANCH |
| 1 | 1SV17MBA07 | CLINTON ELIAZER ABRAHAM | M | II YEAR | MBA |
| 2 | 1SV17SCS03 | TIENKOUA GUELABLIHI MARDOCHEE | M | II YEAR | SCS |

| TABLE TENNIS | | | | | |
|--------------|------------|---------------------|--------|---------|--------|
| SLNO | USN | NAME OF THE STUDENT | GENDER | YEAR | BRANCH |
| 1 | 1SV17BBT02 | RAJ KUMAR PATEL | M | II YEAR | BBT |
| 2 | 1SV17MBA11 | KOUSHIK KUMAR H P | M | II YEAR | MBA |

| HAND BALL | | | | | |
|-----------|------------|---------------------|--------|---------|--------|
| SLNO | USN | NAME OF THE STUDENT | GENDER | YEAR | BRANCH |
| 1 | 1SV17MBA18 | MUBARAK | M | II YEAR | MBA |
| 2 | 1SV18MBA30 | VIDYA. J. KUNNUR. | M | I YEAR | MBA |
| 3 | 1SV18MMD01 | JAYANTH. C. | M | I YEAR | MMD |
| 4 | 1SV17MBA23 | PRASANNAKUMAR C | M | II YEAR | MBA |
| 5 | 1SV18MBA09 | LOHITHA. T. R. | M | I YEAR | MBA |
| 6 | 1SV18MBA18 | NAGESH. G. | M | I YEAR | MBA |
| 7 | 1SV18MBA28 | SHASHIKUMAR. B. L. | M | I YEAR | MBA |
| 8 | 1SV17MBA05 | BHARATH T S | M | II YEAR | MBA |
| 9 | 1SV17MBA02 | ANIL KUMAR R C | M | II YEAR | MBA |
| 10 | 1SV17MBA29 | VEERESHA YADAV M K | M | II YEAR | MBA |
| 11 | 1SV18CCS01 | RAGHAVENDRA TEVARI | M | I YEAR | CCS |

| FOOT BALL | | | | | |
|-----------|------------|----------------------------------|--------|---------|--------|
| SLNO | USN | NAME OF THE STUDENT | GENDER | YEAR | BRANCH |
| 1 | 1SV17MBA05 | BHARATH T S | M | II YEAR | MBA |
| 2 | 1SV17MBA07 | CLINTON ELIAZER ABRAHAM | M | II YEAR | MBA |
| 3 | 1SV17MBA11 | KOUSHIK KUMAR H P | M | II YEAR | MBA |
| 4 | 1SV17MBA29 | VEERESHA YADAV M K | M | II YEAR | MBA |
| 5 | 1SV18MBA07 | JOSEPH ANTONY | M | I YEAR | MBA |
| 6 | 1SV18MBA09 | LOHITHA. T. R. | M | I YEAR | MBA |
| 7 | 1SV18MBA02 | ANANTHU. S. M. | M | I YEAR | MBA |
| 8 | 1SV18MBA26 | SANDEEPA. R. | M | I YEAR | MBA |
| 9 | 1SV18MBA24 | RANJITHA. K. R. | M | I YEAR | MBA |
| 10 | 1SV18MBA30 | VIDYA. J. KUNNUR. | M | I YEAR | MBA |
| 11 | 1SV18MBA14 | MANI. S. | M | I YEAR | MBA |
| 12 | 1SV18MMD02 | B. VENKATESHA. | M | I YEAR | MMD |
| 13 | 1SV17SCS03 | TIENKOUA GUELABLIHI MARDOCHEE | M | II YEAR | SCS |
| 14 | 1SV17BBT02 | RAJ KUMAR PATEL | M | II YEAR | BBT |
| 15 | 1SV17SCS02 | SEHIN GNONEBO RODRIGUE | M | II YEAR | SCS |
| 16 | 1SV18BBT04 | NAVEEN KUMAR. H. M. | M | I YEAR | BBT |

| THROW BALL | | | | | |
|------------|------------|---------------------|--------|---------|--------|
| SLNO | USN | NAME OF THE STUDENT | GENDER | YEAR | BRANCH |
| 1 | 1SV18MBA15 | MANJUSHREE. B. G. | F | I YEAR | MBA |
| 2 | 1SV18MBA21 | POOJA. C. | F | I YEAR | MBA |
| 3 | 1SV18MBA22 | PRIYANKA KUMARI. | F | I YEAR | MBA |
| 4 | 1SV18MBA25 | RUMANA KHANUM | F | I YEAR | MBA |
| 5 | 1SV17MBA06 | CHAITHRA H R | F | II YEAR | MBA |
| 6 | 1SV17MBA08 | GOWRAMMA G S | F | II YEAR | MBA |
| 7 | 1SV17MBA09 | HELEN SUPRIYA S | F | II YEAR | MBA |
| 8 | 1SV17MBA10 | KALPANA A | F | II YEAR | MBA |
| 9 | 1SV17MBA12 | KUBRA FATHIMA | F | II YEAR | MBA |
| 10 | 1SV17MBA13 | KUMARI SHANTI USHA | F | II YEAR | MBA |
| 11 | 1SV17MBA16 | MANJUSHREE M | F | II YEAR | MBA |
| 12 | 1SV17MBA22 | POORNIMA A S | F | II YEAR | MBA |

| KHO KHO | | | | | |
|---------|------------|---------------------|--------|---------|--------|
| SLNO | USN | NAME OF THE STUDENT | GENDER | YEAR | BRANCH |
| 1 | 1SV18MBA01 | AMUDHA. | F | I YEAR | MBA |
| 2 | 1SV18MBA05 | HIMANI SONAL. | F | I YEAR | MBA |
| 3 | 1SV18MBA08 | KAVYA. V. | F | I YEAR | MBA |
| 4 | 1SV18MBA13 | MALA.C. | F | I YEAR | MBA |
| 5 | 1SV18MBA15 | MANJUSHREE. B. G. | F | I YEAR | MBA |
| 6 | 1SV17MBA16 | MANJUSHREE M | F | II YEAR | MBA |
| 7 | 1SV17MBA22 | POORNIMA A S | F | II YEAR | MBA |
| 8 | 1SV17MBA24 | RACHANA B | F | II YEAR | MBA |
| 9 | 1SV17MBA27 | SHAHEEN TAJ C | F | II YEAR | MBA |
| 10 | 1SV17MBA28 | THIVENI B M | F | II YEAR | MBA |
| 11 | 1SV17MBA09 | HELEN SUPRIYA S | F | II YEAR | MBA |
| 12 | 1SV17MBA10 | KALPANA A | F | II YEAR | MBA |

| BALL BADMINTON | | | | | |
|----------------|------------|---------------------|--------|---------|--------|
| SLNO | USN | NAME OF THE STUDENT | GENDER | YEAR | BRANCH |
| 1 | 1SV18MBA08 | KAVYA. V. | F | I YEAR | MBA |
| 2 | 1SV18MBA13 | MALA.C. | F | I YEAR | MBA |
| 3 | 1SV18MBA15 | MANJUSHREE. B. G. | F | I YEAR | MBA |
| 4 | 1SV18MBA21 | POOJA. C. | F | I YEAR | MBA |
| 5 | 1SV18MBA22 | PRIYANKA KUMARI. | F | I YEAR | MBA |
| 6 | 1SV17MBA13 | KUMARI SHANTI USHA | F | II YEAR | MBA |
| 7 | 1SV17MBA16 | MANJUSHREE M | F | II YEAR | MBA |
| 8 | 1SV17MBA22 | POORNIMA A S | F | II YEAR | MBA |
| 9 | 1SV17MBA24 | RACHANA B | F | II YEAR | MBA |
| 10 | 1SV17MBA27 | SHAHEEN TAJ C | F | II YEAR | MBA |

| SHATAL BADMINTON | | | | | |
|------------------|------------|---------------------|--------|---------|--------|
| SLNO | USN | NAME OF THE STUDENT | GENDER | YEAR | BRANCH |
| 1 | 1SV18MBA13 | MALA.C. | F | I YEAR | MBA |
| 2 | 1SV18MBA15 | MANJUSHREE. B. G. | F | I YEAR | MBA |
| 3 | 1SV18MBA21 | POOJA. C. | F | I YEAR | MBA |
| 4 | 1SV17MBA09 | HELEN SUPRIYA S | F | II YEAR | MBA |
| 5 | 1SV17MBA10 | KALPANA A | F | II YEAR | MBA |

| CAROM | | | | | |
|-------|------------|---------------------|--------|---------|--------|
| SLNO | USN | NAME OF THE STUDENT | GENDER | YEAR | BRANCH |
| 1 | 1SV17MBA28 | THIVENI B M | F | II YEAR | MBA |
| 2 | 1SV17MBA09 | HELEN SUPRIYA S | F | II YEAR | MBA |

| CHESS | | | | | |
|-------|------------|---------------------|--------|--------|--------|
| SLNO | USN | NAME OF THE STUDENT | GENDER | YEAR | BRANCH |
| 1 | 1SV18MBA22 | PRIYANKA KUMARI. | F | I YEAR | MBA |
| 2 | 1SV18MBA05 | HIMANI SONAL. | F | I YEAR | MBA |

| TABLE TENNIS | | | | | |
|--------------|------------|---------------------|--------|---------|--------|
| SLNO | USN | NAME OF THE STUDENT | GENDER | YEAR | BRANCH |
| 1 | 1SV18MBA25 | RUMANA KHANUM | F | I YEAR | MBA |
| 2 | 1SV17MBA22 | POORNIMA A S | F | II YEAR | MBA |

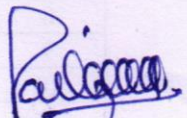
 Head of the Department
 MBA Program
 S.J.E.T. Tumkur

Shridevi Institute of Engineering and Technology, Tumkur - 572106

Department of Physical Education

Date: 30/11/2018

Sports Fixtures

1. Throw Ball (03-12-2018) 11.30 AM

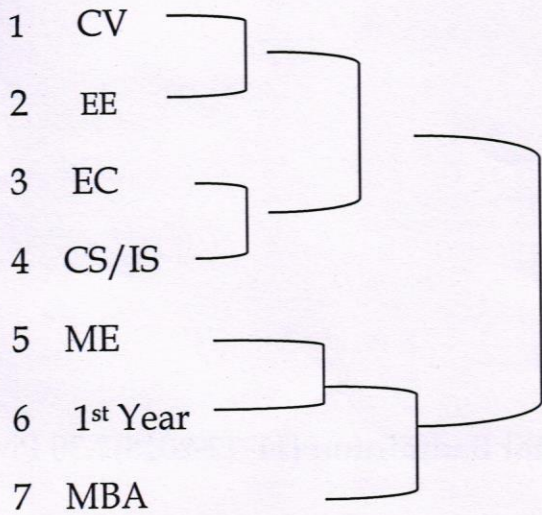

2. Volley Ball (04-12-2018) 2.30 PM

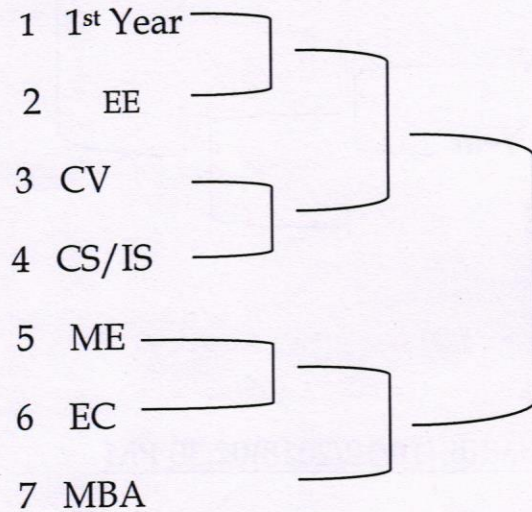

3. Kho Kho (06-12-2018) 2.30 PM

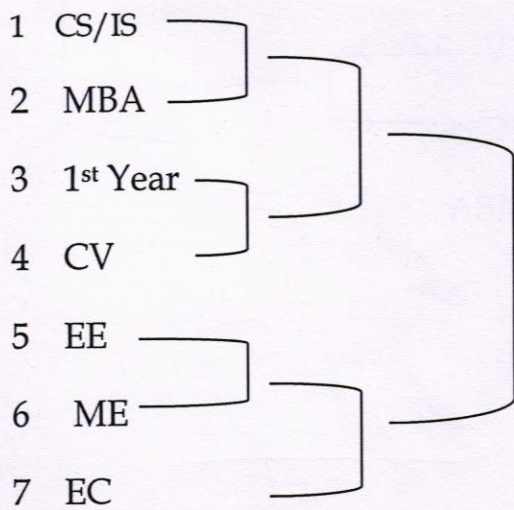

4. Cricket (07/12/2018) 02.30 PM

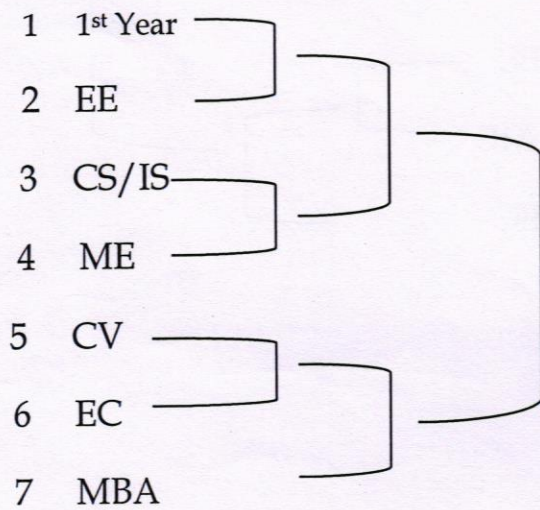

5. Ball Badminton (10-12-2018) 2.30 PM

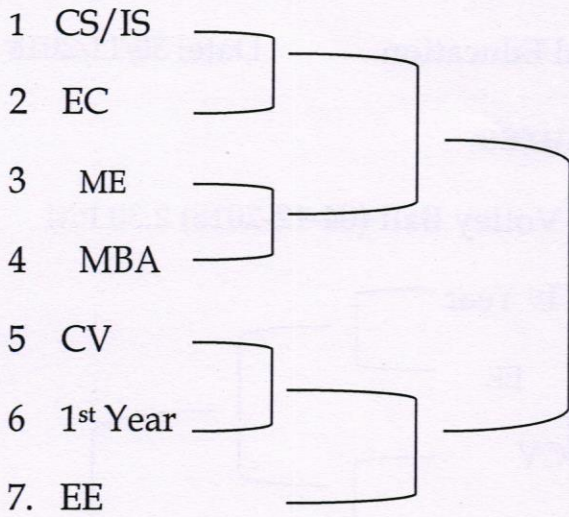

6. Kabaddi (10/12/2018) 02.30 PM

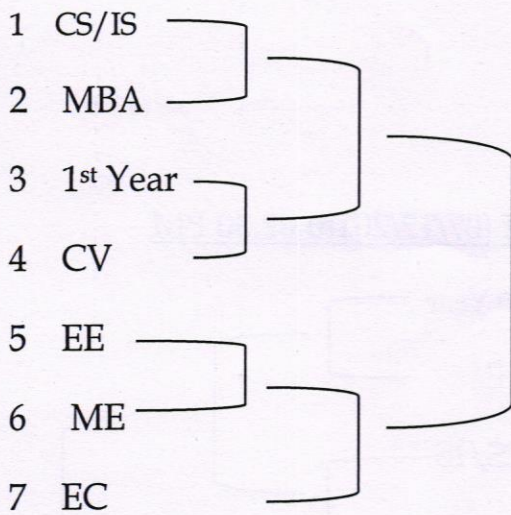

7. Shatal Badminton (11-12-2018) 2.30 PM

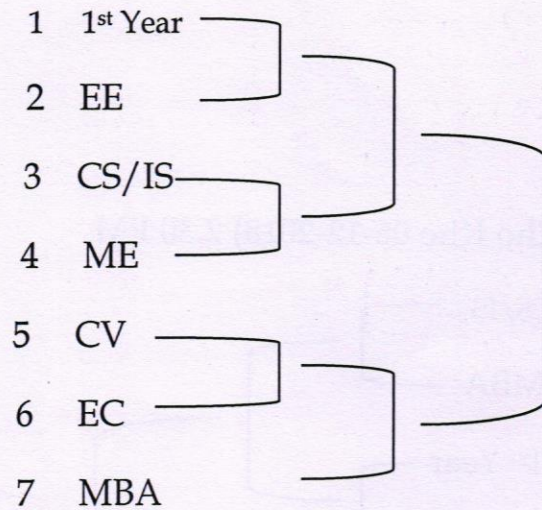

8. Basketball (12-12-2018)2.30 PM

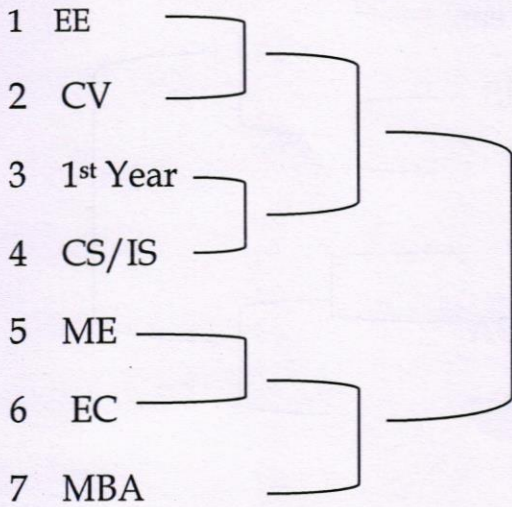

9. Carom (13-12-2018) 2.30 PM

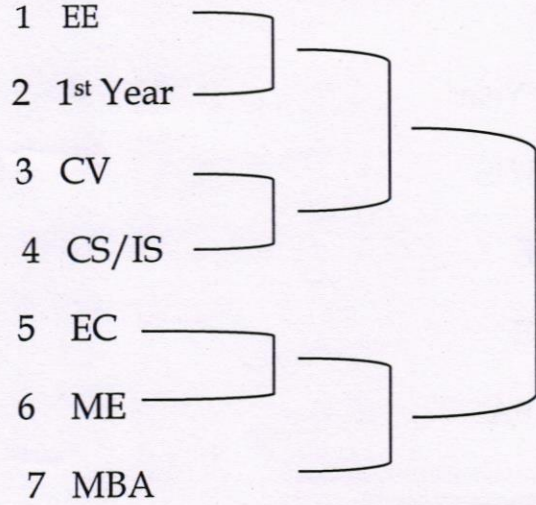

10. Chess (13-12-2018) 2.30 PM

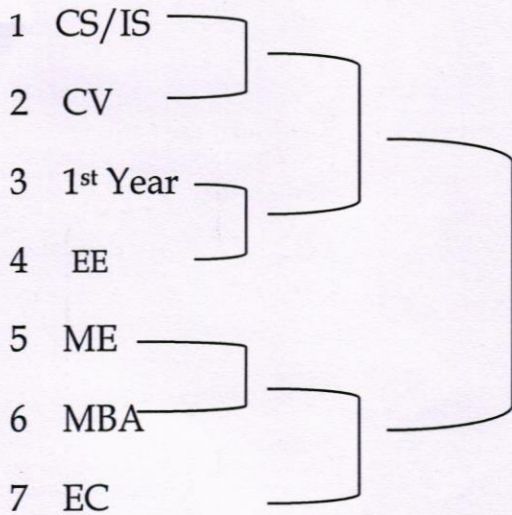

11. Table Tennis (14-12-2018) 2.30 PM

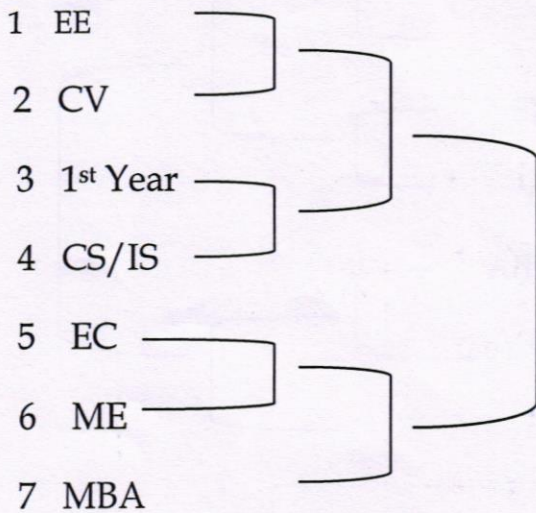

12. Gim (15-12-2018) 10.30 AM

- 1 EE
- 2 CV
- 3 1st Year
- 4 CS/IS
- 5 ME
- 6 EC
- 7 MBA

13. Hand ball (17-12-2018) 11.30 AM

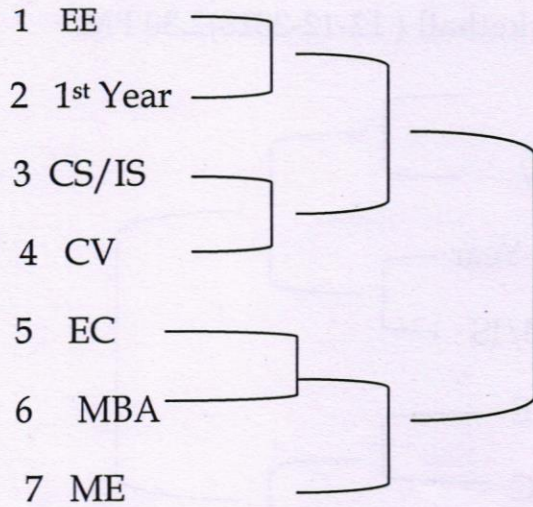

14. Foot Ball (18-12-2018) 2.30 PM

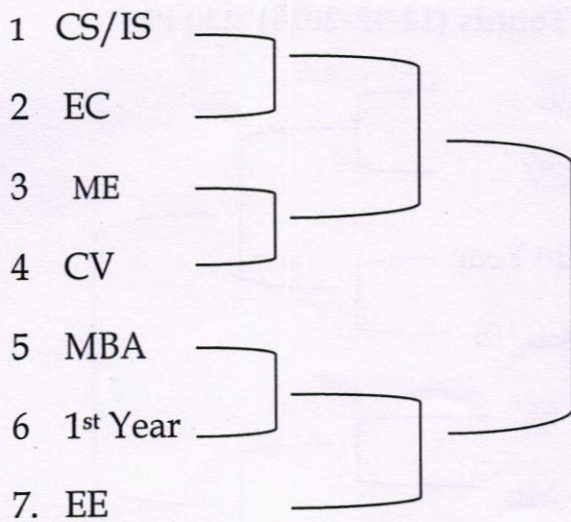

Copy to HODs: CS/EC/EE/ME/IS/CIVIL/MBA/First Year/ Academic coordinator

(Mr.Raghavendra Jattendra)

PED SIET

(9880984474)

Physical Education Director.

Dept. of Physical Education.

Shridevi Institute of Engineering & Technology

Sira Road, Tumkur-572106

PRINCIPAL
SIET, TUMKUR

(Dr. Hemadri Naidu.T)

PRINCIPAL

SHRIDEVI INSTITUTE OF
ENGINEERING AND TECHNOLOGY
TUMKUR - 572106

SNAP SHOTS OF ANNUAL INTER DEPARTMENTAL SPORTS ACTIVITIES

CRICKET INAUGURATED BY Dr. NARENDRA VISWANATH



WINNER TEAM:



RUNNER TEAM:



**Shridevi Institute of Engineering and Technology,
Tumkur - 572106**

Department of Physical Education

Date: 22/12/2018

WINNER LIST

| Sl.No. | NAME OF THE EVENT | EVENT WINNERS | |
|--------|-------------------|--|---------------------------------------|
| | | I ST PLACE | II ND PLACE |
| 1 | Throw Ball | CSE (Girls) | MBA (Girls) |
| 2 | Volley Ball | EC(Boys) & EC (girls) | EEE(Boys) & CSE IS (girls) |
| 3 | Kho Kho | EC(Boys) & EC(girls) | CS/ISE(Boys) & EEE(girls) |
| 4 | Cricket | Civil(Boys) | ME(Boys) |
| 5 | Ball Badminton | CSE/IS (Boys) & 1 st Year (Girls) | EEE (Boys) & MBA (Girls) |
| 6 | Kabaddi | ME(Boys) | 1 st Year(Boys) |
| 7 | Shatal badminton | EEE(Boys) & CSE/IS(Girls) | EC(Boys) & EE(Girls) |
| 8 | Basketball | ME(Boys) | CSE/ISE(Boys) |
| 9 | Carom | CSE/IS(Boys) & EC(Girls) | EC(Boys) & MBA(Girls) |
| 10 | Chess | CSE/IS(Boy) & EC (Girl) | CIVIL(Boy) & EEE (Girl) |
| 11 | Table Tennis | ME(Boy) & EC (Girl) | EC(Boy) & MBA (Girl) |
| 12 | Gim | ME (Boy) | CSE (Boy) |
| 13 | Hand ball | Civil(Boys) | 1 st Year(Boys) |
| 14 | Foot Ball | ME (Boys) | Civil (Boys) |



(Mr. Raghavendra Jattendra)

PED SIET

(9880984474)

Physical Education Director.

Dept. of Physical Education.

Shridevi Institute of Engineering & Technology

Sira Road, Tumkur-572106

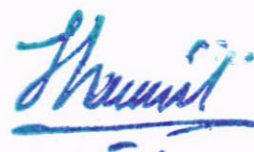

(Dr. Hemadri Naidu. T)

PRINCIPAL

PRINCIPAL

SHRIDEVI INSTITUTE OF
ENGINEERING AND TECHNOLOGY

TUMKUR - 572106.

**ANNUAL INTER DEPARTMENT SPORTS ACTIVITIES WINNER LIST IN
THE ACCADEMIC YEAR 2018-19**

WINNER LIST

1ST PLACE

| CS/IS | | | | | |
|------------|------------|---------------------|--------|----------|--------|
| THROW BALL | | | | | |
| SLNO | USN | NAME OF THE STUDENT | GENDER | YEAR | BRANCH |
| 1 | 1SV15CS070 | PRIYA PANDA | F | II YEAR | CSE |
| 2 | 1SV17CS003 | AISHWARYA MERY E | F | II YEAR | CSE |
| 3 | 1SV17CS006 | ANUPRIYA SINGH | F | II YEAR | CSE |
| 4 | 1SV17CS009 | BHOOMIKA M | F | II YEAR | CSE |
| 5 | 1SV17CS012 | CHANDANA D GOWDA | F | II YEAR | CSE |
| 6 | 1SV17CS014 | EVA REGMI | F | II YEAR | CSE |
| 7 | 1SV17CS016 | HARSHITHA B A | F | II YEAR | CSE |
| 8 | 1SV15CS012 | BHAVYA B | F | III YEAR | CSE |
| 9 | 1SV15CS022 | HARSHITHA B C | F | III YEAR | CSE |
| 10 | 1SV15CS042 | MEENAKSHI P | F | III YEAR | CSE |
| 11 | 1SV15CS053 | NARGIS NAAZ | F | III YEAR | CSE |
| 12 | 1SV14IS005 | DEEPTHI K S | F | IV YEAR | IS |

2ND PLACE

| MBA | | | | | |
|------------|------------|---------------------|--------|---------|--------|
| THROW BALL | | | | | |
| SLNO | USN | NAME OF THE STUDENT | GENDER | YEAR | BRANCH |
| 1 | 1SV18MBA15 | MANJUSHREE. B. G. | F | I YEAR | MBA |
| 2 | 1SV18MBA21 | POOJA. C. | F | I YEAR | MBA |
| 3 | 1SV18MBA22 | PRIYANKA KUMARI. | F | I YEAR | MBA |
| 4 | 1SV18MBA25 | RUMANA KHANUM | F | I YEAR | MBA |
| 5 | 1SV17MBA06 | CHAITHRA H R | F | II YEAR | MBA |
| 6 | 1SV17MBA08 | GOWRAMMA G S | F | II YEAR | MBA |
| 7 | 1SV17MBA09 | HELEN SUPRIYA S | F | II YEAR | MBA |
| 8 | 1SV17MBA10 | KALPANA A | F | II YEAR | MBA |
| 9 | 1SV17MBA12 | KUBRA FATHIMA | F | II YEAR | MBA |
| 10 | 1SV17MBA13 | KUMARI SHANTI USHA | F | II YEAR | MBA |
| 11 | 1SV17MBA16 | MANJUSHREE M | F | II YEAR | MBA |
| 12 | 1SV17MBA22 | POORNIMA A S | F | II YEAR | MBA |



Physical Education Director.
Dept. of Physical Education.
Shridevi Institute of Engineering & Technology
Sira Road, Tumkur-572106

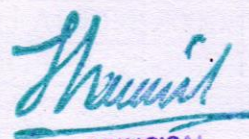

PRINCIPAL
SHRIDEVI INSTITUTE OF
ENGINEERING AND TECHNOLOGY
TUMKUR.- 572106

1ST PLACE

VOLLEY BALL BOYS

| SLNO | USN | NAME OF THE STUDENT | GENDER | YEAR | BRANCH |
|------|------------|-----------------------------|--------|----------|--------|
| 1 | 1SV15EC035 | RAGHURAJ G K | M | III YEAR | ECE |
| 2 | 1SV15EC052 | VISHWAS S P | M | III YEAR | ECE |
| 3 | 1SV15EC001 | ABHISHEK G SHEELVANT | M | IV YEAR | ECE |
| 4 | 1SV15EC009 | CL BALAJI | M | IV YEAR | ECE |
| 5 | 1SV15EC032 | PRASHANT CHOUDRI | M | IV YEAR | ECE |
| 6 | 1SV15EC040 | ROHITH P | M | IV YEAR | ECE |
| 7 | 1SV15EC051 | VINAY S P | M | IV YEAR | ECE |
| 8 | 1SV16EC400 | ABDUL NAZEERSAB A KANAVALLI | M | IV YEAR | ECE |
| 9 | 1SV16EC404 | CHIRANJEEVI K M | M | IV YEAR | ECE |
| 10 | 1SV16EC407 | MANJUNATH B YANNI | M | IV YEAR | ECE |
| 11 | 1SV15EC025 | NITHIN KUMAR G M | M | II YEAR | ECE |
| 12 | 1SV17EC003 | DANIEL S | M | II YEAR | ECE |

2ND PLACE

VOLLEY BALL BOYS

| SLNO | USN | NAME OF THE STUDENT | GENDER | YEAR | BRANCH |
|------|------------|---------------------|--------|----------|--------|
| 1 | 1SV15EE029 | SANDEEP K N | M | II YEAR | EEE |
| 2 | 1SV15EE031 | SHIVAKUMAR A R | M | II YEAR | EEE |
| 3 | 1SV17EE001 | AJITH KUMAR S | M | II YEAR | EEE |
| 4 | 1SV17EE002 | GANESH KUMAR | M | II YEAR | EEE |
| 5 | 1SV17EE004 | MAHESH | M | II YEAR | EEE |
| 6 | 1SV17EE007 | PRAVEEN KUMAR N | M | II YEAR | EEE |
| 7 | 1SV17EE008 | PREMKUMAR R | M | II YEAR | EEE |
| 8 | 1SV17EE010 | SACHIN KUMAR | M | II YEAR | EEE |
| 9 | 1SV15EE023 | MANIKIRAN K R | M | III YEAR | EEE |
| 10 | 1SV15EE030 | SHAMSHIR ANSARI | M | III YEAR | EEE |
| 11 | 1SV14EE006 | CHETHAN S | M | IV YEAR | EEE |
| 12 | 1SV15EE012 | CHETAN T R | M | IV YEAR | EEE |

1ST PLACE GIRLS

ECE

VOLLEYBALL

| SLNO | USN | NAME OF THE STUDENT | GENDER | YEAR | BRANCH |
|------|------------|---------------------|--------|----------|--------|
| 1 | 1SV15EC045 | SUNITHA Y K | F | II YEAR | ECE |
| 2 | 1SV17EC001 | AFRA FATHIMA | F | II YEAR | ECE |
| 3 | 1SV17EC002 | ASHWINI V | F | II YEAR | ECE |
| 4 | 1SV17EC004 | GEETHA M R | F | II YEAR | ECE |
| 5 | 1SV17EC007 | NIDA NAWAZ | F | II YEAR | ECE |
| 6 | 1SV17EC008 | NISHA H | F | II YEAR | ECE |
| 7 | 1SV17EC015 | SAYEEDUNNISA | F | II YEAR | ECE |
| 8 | 1SV15EC027 | NOOR AYESHA | F | III YEAR | ECE |
| 9 | 1SV15EC049 | USHA Y M | F | III YEAR | ECE |
| 10 | 1SV16EC402 | ANUSHA T P | F | III YEAR | ECE |
| 11 | 1SV14EC015 | LAHARI N RAJ | F | IV YEAR | ECE |
| 12 | 1SV15EC002 | AISHWARYA S M | F | IV YEAR | ECE |

2ND PLACE GIRLS

EE

VOLLEYBALL

| SLNO | USN | NAME OF THE STUDENT | GENDER | YEAR | BRANCH |
|------|------------|--------------------------|--------|----------|--------|
| 1 | 1SV18EE400 | CHANDRIKA S | F | II YEAR | EE |
| 2 | 1SV18EE401 | MEGHANA G S | F | II YEAR | EE |
| 3 | 1SV18EE403 | POOJA B N | F | II YEAR | EE |
| 4 | 1SV14EE004 | BHAVYA SHREE N | F | III YEAR | EE |
| 5 | 1SV15EE004 | AMRUTHA | F | III YEAR | EE |
| 6 | 1SV15EE010 | CHAITHRA C | F | III YEAR | EE |
| 7 | 1SV15EE039 | Y T PRIYA | F | III YEAR | EE |
| 8 | 1SV15EE003 | AKSHATHA M P | F | IV YEAR | EE |
| 9 | 1SV15EE007 | ASHWINI T | F | IV YEAR | EE |
| 10 | 1SV15EE008 | BHUVANASHREEHOSAMANE H K | F | IV YEAR | EE |
| 11 | 1SV15EE017 | DIVYASHREE B J | F | IV YEAR | EE |
| 12 | 1SV15EE020 | KASTHURI B NAG | F | IV YEAR | EE |



Physical Education Director.

Dept. of Physical Education.

Shridevi Institute of Engineering & Technology

Sira Road, Tumkur-572106

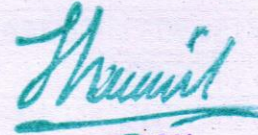

PRINCIPAL

SHRIDEVI INSTITUTE OF
ENGINEERING AND TECHNOLOGY
TUMKUR - 572106

1ST PLACE

| KHO KHO | | | | | |
|---------|------------|---------------------|--------|----------|--------|
| SLNO | USN | NAME OF THE STUDENT | GENDER | YEAR | BRANCH |
| 1 | 1SV16EC408 | MOHANKUMAR D | M | IV YEAR | ECE |
| 2 | 1SV13EC012 | DILEEP S | M | IV YEAR | ECE |
| 3 | 1SV13EC020 | KEERTHY N | M | IV YEAR | ECE |
| 4 | 1SV13EC059 | Y MAHESH SINGH | M | IV YEAR | ECE |
| 5 | 1SV14EC002 | ANJU N | M | IV YEAR | ECE |
| 6 | 1SV14EC408 | SUPREETH C | M | IV YEAR | ECE |
| 7 | 1SV17EC009 | NISHATH NAWAZ | M | II YEAR | ECE |
| 8 | 1SV17EC011 | RAKESH K L | M | II YEAR | ECE |
| 9 | 1SV18EC402 | LOKESHA G H | M | II YEAR | ECE |
| 10 | 1SV15EC005 | ARUN C G | M | III YEAR | ECE |
| 11 | 1SV15EC035 | RAGHURAJ G K | M | III YEAR | ECE |
| 12 | 1SV15EC052 | VISHWAS S P | M | III YEAR | ECE |

2ND PLACE

| KHO KHO | | | | | |
|---------|------------|---------------------|--------|----------|--------|
| SLNO | USN | NAME OF THE STUDENT | GENDER | YEAR | BRANCH |
| 1 | 1SV14CS057 | ROHAN B P | M | IV YEAR | CSE |
| 2 | 1SV15CS034 | KIRAN A S | M | IV YEAR | CSE |
| 3 | 1SV15CS035 | KUMAR DAHAL | M | IV YEAR | CSE |
| 4 | 1SV15CS043 | MEER KAREE MUDDIN | M | III YEAR | CSE |
| 5 | 1SV15CS049 | MUKESH REDDY K A | M | III YEAR | CSE |
| 6 | 1SV15CS079 | RAVI UJJWAL | M | III YEAR | CSE |
| 7 | 1SV17CS035 | RAJESH KUMAR KAHAR | M | II YEAR | CSE |
| 8 | 1SV17CS037 | SADANAND KUMAR | M | II YEAR | CSE |
| 9 | 1SV17CS038 | SAURABH PANDEY | M | II YEAR | CSE |
| 10 | 1SV15IS009 | NARASIMHAMURTHY N | M | III YEAR | IS |
| 11 | 1SV15IS014 | SAGAR R | M | III YEAR | IS |
| 12 | 1SV15IS008 | MADHAN J | M | IV YEAR | IS |

1ST PLACE

| ECE | | | | | |
|---------|------------|---------------------|--------|----------|--------|
| KHO KHO | | | | | |
| SLNO | USN | NAME OF THE STUDENT | GENDER | YEAR | BRANCH |
| 1 | 1SV15EC045 | SUNITHA Y K | F | II YEAR | ECE |
| 2 | 1SV17EC001 | AFRA FATHIMA | F | II YEAR | ECE |
| 3 | 1SV17EC002 | ASHWINI V | F | II YEAR | ECE |
| 4 | 1SV17EC004 | GEETHA M R | F | II YEAR | ECE |
| 5 | 1SV17EC007 | NIDA NAWAZ | F | II YEAR | ECE |
| 6 | 1SV17EC008 | NISHA H | F | II YEAR | ECE |
| 7 | 1SV17EC015 | SAYEEDUNNISA | F | II YEAR | ECE |
| 8 | 1SV15EC027 | NOOR AYESHA | F | III YEAR | ECE |
| 9 | 1SV15EC049 | USHA Y M | F | III YEAR | ECE |
| 10 | 1SV16EC402 | ANUSHA T P | F | III YEAR | ECE |
| 11 | 1SV14EC015 | LAHARI N RAJ | F | IV YEAR | ECE |
| 12 | 1SV15EC002 | AISHWARYA S M | F | IV YEAR | ECE |

2ND PLACE

EE

KHO KHO

| SLNO | USN | NAME OF THE STUDENT | GENDER | YEAR | BRANCH |
|------|------------|---------------------|--------|----------|--------|
| 1 | 1SV18EE400 | CHANDRIKA S | F | II YEAR | EE |
| 2 | 1SV18EE401 | MEGHANA G S | F | II YEAR | EE |
| 3 | 1SV18EE403 | POOJA B N | F | II YEAR | EE |
| 4 | 1SV14EE004 | BHAVYA SHREE N | F | III YEAR | EE |
| 5 | 1SV15EE004 | AMRUTHA | F | III YEAR | EE |
| 6 | 1SV15EE010 | CHAITHRA C | F | III YEAR | EE |
| 7 | 1SV15EE039 | Y T PRIYA | F | III YEAR | EE |
| 8 | 1SV15EE003 | AKSHATHA M P | F | IV YEAR | EE |
| 9 | 1SV15EE007 | ASHWINI T | F | IV YEAR | EE |
| 10 | 1SV15EE008 | BHUVANASHREEHOSAMA | F | IV YEAR | EE |
| 11 | 1SV15EE017 | DIVYASHREE B J | F | IV YEAR | EE |
| 12 | 1SV15EE020 | KASTHURI B NAG | F | IV YEAR | EE |

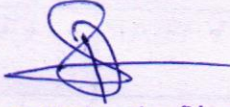

Physical Education Director.

Dept. of Physical Education.

Shridevi Institute of Engineering & Technology

Sira Road, Tumkur-572106

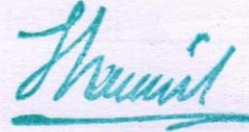

PRINCIPAL

SHRIDEVI INSTITUTE OF
ENGINEERING AND TECHNOLOGY

TUMKUR - 572106

1ST PLACE

| CRICKET | | | | | |
|---------|------------|-----------------------------|--------|----------|--------|
| SLNO | USN | NAME OF THE STUDENT | GENDER | YEAR | BRANCH |
| 1 | 1SV15CV009 | BIKRAM KHATRI | M | IV YEAR | CV |
| 2 | 1SV17CV013 | PUNITHKUMAR K B | M | II YEAR | CV |
| 3 | 1SV15CV012 | CHETHAN KUMAR NH | M | IV YEAR | CV |
| 4 | 1SV15CV013 | DHANUSH H M | M | IV YEAR | CV |
| 5 | 1SV17CV027 | NAWAZ KHAN KN | M | II YEAR | CV |
| 6 | 1SV17CV026 | RAVI TEJU M | M | II YEAR | CV |
| 7 | 1SV15CV006 | AURANGZEB ALAM ANSARI | M | III YEAR | CV |
| 8 | 1SV13CV013 | GEZIT BOY KARAM | M | IV YEAR | CV |
| 9 | 1SV12CV002 | AKSHAY C J | M | IV YEAR | CV |
| 10 | 1SV12CV035 | RAGHAVENDRA A | M | IV YEAR | CV |
| 11 | 1SV13CV023 | KENTO LOYA | M | IV YEAR | CV |
| 12 | 1SV13CV035 | MOIRANGTHEM HEMJIT SINGH | M | IV YEAR | CV |

2ND PLACE

| CRICKET | | | | | |
|---------|------------|------------------------------------|--------|----------|--------|
| SLNO | USN | NAME OF THE STUDENT | GENDER | YEAR | BRANCH |
| 1 | 1SV15ME019 | HARISH KUMAR K T | M | IV YEAR | ME |
| 2 | 1SV15ME023 | KARTHIK G K | M | IV YEAR | ME |
| 3 | 1SV15ME037 | MARUTI DODMANI | M | III YEAR | ME |
| 4 | 1SV15ME038 | MD ARSHAD ASHFAQUE | M | III YEAR | ME |
| 5 | 1SV15ME052 | PRAVEEN KUMAR G N | M | III YEAR | ME |
| 6 | 1SV14ME088 | VIJAYAKUMAR KALLAPPAGOUDA PATIL | M | III YEAR | ME |
| 7 | 1SV15ME006 | AMARNATH M | M | III YEAR | ME |
| 8 | 1SV18ME402 | KARTHIK Y N | M | II YEAR | ME |
| 9 | 1SV18ME403 | MUHAMMED SHUMAZ SHARIER | M | II YEAR | ME |
| 10 | 1SV18ME404 | NAVEENKUMARA | M | II YEAR | ME |
| 11 | 1SV18ME406 | RAVINDRANATHA K | M | II YEAR | ME |
| 12 | 1SV17ME001 | ABHISHEK KUMBAR | M | II YEAR | ME |

 Physical Education Director.
 Dept. of Physical Education.
 Shridevi Institute of Engineering & Technology
 Sira Road, Tumkur-572106

 PRINCIPAL
 SHRIDEVI INSTITUTE OF
 ENGINEERING AND TECHNOLOGY
 TUMKUR - 572106.

1ST PLACE

| BALL BADMINTON | | | | | |
|----------------|------------|------------------------|--------|----------|--------|
| SLNO | USN | NAME OF THE STUDENT | GENDER | YEAR | BRANCH |
| 1 | 1SV17CS004 | AMAN PRASAD KALWAR | M | II YEAR | CSE |
| 2 | 1SV17CS005 | ANIL GOWDA | M | II YEAR | CSE |
| 3 | 1SV17CS008 | B RAMESH | M | II YEAR | CSE |
| 4 | 1SV15CS049 | MUKESH REDDY K A | M | III YEAR | CSE |
| 5 | 1SV15CS079 | RAVI UJJWAL | M | III YEAR | CSE |
| 6 | 1SV15CS082 | SAGAR B R | M | III YEAR | CSE |
| 7 | 1SV14CS009 | BHARATHA C HEGADE | M | IV YEAR | CSE |
| 8 | 1SV17IS001 | NITHIN KUMAR B N | M | II YEAR | IS |
| 9 | 1SV17IS004 | SANTHOSH BHARADWAJ H A | M | II YEAR | IS |
| 10 | 1SV15IS017 | SUSHANTH A JAIN | M | IV YEAR | IS |

2ND PLACE

| BALL BADMINTON | | | | | |
|----------------|------------|----------------------------|--------|----------|--------|
| SLNO | USN | NAME OF THE STUDENT | GENDER | YEAR | BRANCH |
| 1 | 1SV15EE036 | VIJAY G R | M | IV YEAR | EEE |
| 2 | 1SV16EE404 | MURULIDHARA G | M | IV YEAR | EEE |
| 3 | 1SV13EE001 | ABHISHEK B S | M | IV YEAR | EEE |
| 4 | 1SV14EE014 | MITHUN M | M | IV YEAR | EEE |
| 5 | 1SV14EE016 | NIKHIL B N | M | IV YEAR | EEE |
| 6 | 1SV15EE409 | LOKESHA H | M | IV YEAR | EEE |
| 7 | 1SV15EE029 | SANDEEP K N | M | II YEAR | EEE |
| 8 | 1SV17EE004 | MAHESH | M | II YEAR | EEE |
| 9 | 1SV17EE001 | AJITH KUMAR S | M | II YEAR | EEE |
| 10 | 1SV15EE022 | KUMAR PARAMESHWAR HEGDE | M | III YEAR | EEE |

1ST PLACE

| BALL BADMINTON | | | | | |
|----------------|------------|---------------------|--------|--------|--------|
| SLNO | USN | NAME OF THE STUDENT | GENDER | YEAR | BRANCH |
| 1 | 1SV18CS014 | ENCHARA M | F | I YEAR | CSE |
| 2 | 1SV18CS015 | GAGANA N | F | I YEAR | CSE |
| 3 | 1SV18CS020 | HARSHITHA S | F | I YEAR | CSE |
| 4 | 1SV18CS033 | PRIYADARSHINI R | F | I YEAR | CSE |
| 5 | 1SV18CS034 | RAKSHITHA RANGANATH | F | I YEAR | CSE |
| 6 | 1SV18CS038 | SHRADDHA S | F | I YEAR | CSE |
| 7 | 1SV18CS044 | UMME HANNE | F | I YEAR | CSE |
| 8 | 1SV18CS045 | VIJAYALAXMI | F | I YEAR | CSE |
| 9 | 1SV18EC002 | ANUSHA G S | F | I YEAR | ECE |
| 10 | 1SV18CV012 | DEVIKA. K. PATIL. | F | I YEAR | CV |

Physical Education Director.

Dept. of Physical Education.

Shridevi Institute of Engineering & Technology
Sira Road, Tumkur-572106

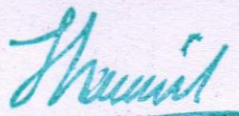
PRINCIPAL

SHRIDEVI INSTITUTE OF
ENGINEERING AND TECHNOLOGY
TUMKUR - 572106

2ND PLACE

BALL BADMINTON

| SLNO | USN | NAME OF THE STUDENT | GENDER | YEAR | BRANCH |
|------|------------|---------------------|--------|---------|--------|
| 1 | 1SV18MBA08 | KAVYA. V. | F | I YEAR | MBA |
| 2 | 1SV18MBA13 | MALA.C. | F | I YEAR | MBA |
| 3 | 1SV18MBA15 | MANJUSHREE. B. G. | F | I YEAR | MBA |
| 4 | 1SV18MBA21 | POOJA. C. | F | I YEAR | MBA |
| 5 | 1SV18MBA22 | PRIYANKA KUMARI. | F | I YEAR | MBA |
| 6 | 1SV17MBA13 | KUMARI SHANTI USHA | F | II YEAR | MBA |
| 7 | 1SV17MBA16 | MANJUSHREE M | F | II YEAR | MBA |
| 8 | 1SV17MBA22 | POORNIMA A S | F | II YEAR | MBA |
| 9 | 1SV17MBA24 | RACHANA B | F | II YEAR | MBA |
| 10 | 1SV17MBA27 | SHAHEEN TAJ C | F | II YEAR | MBA |



Physical Education Director.

Dept. of Physical Education.

Shridevi Institute of Engineering & Technology

Sira Road, Tumkur-572106

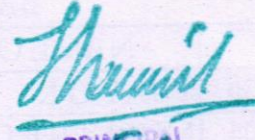

PRINCIPAL

SHRIDEVI INSTITUTE OF
ENGINEERING AND TECHNOLOGY
TUMKUR - 572106

1ST PLACE

KABADDI

| SLNO | USN | NAME OF THE STUDENT | GENDER | YEAR | BRANCH |
|------|------------|-------------------------------|--------|----------|--------|
| 1 | 1SV15ME079 | TIRUPATI MOTEPPA RATHOD | M | IV YEAR | ME |
| 2 | 1SV15ME083 | VINOD T H | M | IV YEAR | ME |
| 3 | 1SV16ME400 | ANANDKUMAR D | M | IV YEAR | ME |
| 4 | 1SV16ME402 | CHETAN M PATIL | M | IV YEAR | ME |
| 5 | 1SV16ME403 | HARISH J | M | IV YEAR | ME |
| 6 | 1SV16ME404 | HARISHA L | M | IV YEAR | ME |
| 7 | 1SV15ME052 | PRAVEEN KUMAR G N | M | III YEAR | ME |
| 8 | 1SV15ME060 | SACHIN CHANDRAKANT BIRADAR | M | III YEAR | ME |
| 9 | 1SV17ME013 | SHRINATH JADHAV | M | II YEAR | ME |
| 10 | 1SV18ME400 | BHANUPRAKASH | M | II YEAR | ME |
| 11 | 1SV17ME008 | PAVAN M S | M | II YEAR | ME |
| 12 | 1SV14ME047 | MANOJ KUMAR V N | M | III YEAR | ME |

2ND PLACE

KABADDI

| SLNO | USN | NAME OF THE STUDENT | GENDER | YEAR | BRANCH |
|------|------------|----------------------|--------|--------|--------|
| 1 | 1SV18EC023 | SRINIVAS C | M | I YEAR | ECE |
| 2 | 1SV18EE001 | ABHISHEK G M | M | I YEAR | EEE |
| 3 | 1SV18CS025 | MANORANJAN P M | M | I YEAR | CSE |
| 4 | 1SV18CS037 | SHASHI BHUSHAN KUMAR | M | I YEAR | CSE |
| 5 | 1SV18EC020 | SAMEER BICHAGATTI | M | I YEAR | ECE |
| 6 | 1SV18EE007 | PREETHAM M | M | I YEAR | EEE |
| 7 | 1SV18ME011 | SAGAR DASIKOP | M | I YEAR | ME |
| 8 | 1SV18CV001 | AKARSH CHANDRAKANTH. | M | I YEAR | CV |
| 9 | 1SV18CV017 | HRUTHVIK. P. | M | I YEAR | CV |
| 10 | 1SV18CV034 | SURYA KIRAN. M. D. | M | I YEAR | CV |
| 11 | 1SV18ME005 | MOHAMED ROSHAN D | M | I YEAR | ME |
| 12 | 1SV18ME002 | BHARATH N M | M | I YEAR | ME |



Physical Education Director.
Dept. of Physical Education.
Shridevi Institute of Engineering & Technology
Sira Road, Tumkur-572106

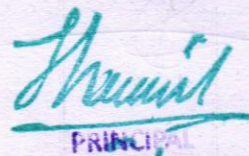

SHRIDEVI INSTITUTE OF
ENGINEERING AND TECHNOLOGY
TUMKUR - 572106

1ST PLACE

| SHATAL BADMINTON | | | | | |
|------------------|------------|---------------------|--------|----------|--------|
| SLNO | USN | NAME OF THE STUDENT | GENDER | YEAR | BRANCH |
| 1 | 1SV17EE007 | PRAVEEN KUMAR N | M | II YEAR | EEE |
| 2 | 1SV14EE001 | AKSHAYKUMAR GK | M | III YEAR | EEE |
| 3 | 1SV15EE030 | SHAMSHIR ANSARI | M | III YEAR | EEE |
| 4 | 1SV14EE006 | CHETHAN S | M | IV YEAR | EEE |
| 5 | 1SV14EE016 | NIKHIL B N | M | IV YEAR | EEE |

2ND PLACE

| SHATAL BADMINTON | | | | | |
|------------------|------------|----------------------|--------|----------|--------|
| SLNO | USN | NAME OF THE STUDENT | GENDER | YEAR | BRANCH |
| 1 | 1SV17EC006 | MD TAJ HUSSAIN | M | II YEAR | ECE |
| 2 | 1SV15EC035 | RAGHURAJ G K | M | III YEAR | ECE |
| 3 | 1SV15EC052 | VISHWAS S P | M | III YEAR | ECE |
| 4 | 1SV15EC001 | ABHISHEK G SHEELVANT | M | IV YEAR | ECE |
| 5 | 1SV15EC009 | CL BALAJI | M | IV YEAR | ECE |

1ST PLACE

| SHATAL BADMINTON | | | | | |
|------------------|------------|---------------------|--------|---------|--------|
| SLNO | USN | NAME OF THE STUDENT | GENDER | YEAR | BRANCH |
| 1 | 1SV15CS102 | VIMALA T | F | IV YEAR | CSE |
| 2 | 1SV15CS104 | VYSIRI DEV | F | IV YEAR | CSE |
| 3 | 1SV15IS007 | LAKSHMIDEVI | F | IV YEAR | IS |
| 4 | 1SV15IS011 | NIVEDITHA S | F | IV YEAR | IS |
| 5 | 1SV14IS005 | DEEPTHI K S | F | IV YEAR | IS |

2ND PLACE

| SHATAL BADMINTON | | | | | |
|------------------|------------|---------------------|--------|----------|--------|
| SLNO | USN | NAME OF THE STUDENT | GENDER | YEAR | BRANCH |
| 1 | 1SV17EE003 | KEERTANA R | F | II YEAR | EE |
| 2 | 1SV17EE005 | MEGHA N | F | II YEAR | EE |
| 3 | 1SV15EE039 | Y T PRIYA | F | III YEAR | EE |
| 4 | 1SV15EE003 | AKSHATHA M P | F | IV YEAR | EE |
| 5 | 1SV15EE007 | ASHWINI T | F | IV YEAR | EE |



Physical Education Director.

Dept. of Physical Education.

Shridevi Institute of Engineering & Technology

Sira Road, Tumkur-572106



PRINCIPAL

SHRIDEVI INSTITUTE OF
ENGINEERING AND TECHNOLOGY
TUMKUR - 572106

1ST PLACE

BASKET BALL

| SLNO | USN | NAME OF THE STUDENT | GENDER | YEAR | BRANCH |
|------|------------|-------------------------|--------|----------|--------|
| 1 | 1SV15ME077 | SRIDHAR N J | M | IV YEAR | ME |
| 2 | 1SV15ME079 | TIRUPATI MOTEPPA RATHOD | M | IV YEAR | ME |
| 3 | 1SV16ME411 | NITHIN KUMAR J N | M | III YEAR | ME |
| 4 | 1SV16ME415 | PRATHAP R N | M | III YEAR | ME |
| 5 | 1SV14ME011 | BHARATH KALMANE G | M | IV YEAR | ME |
| 6 | 1SV14ME016 | CHETHAN G S | M | IV YEAR | ME |
| 7 | 1SV18ME407 | SAGAR R | M | II YEAR | ME |
| 8 | 1SV18ME408 | SRIKANTH K S | M | II YEAR | ME |
| 9 | 1SV15ME088 | TANVEER KHAN | M | II YEAR | ME |
| 10 | 1SV14ME006 | AKSHAY A | M | III YEAR | ME |

2ND PLACE

BASKET BALL

| SLNO | USN | NAME OF THE STUDENT | GENDER | YEAR | BRANCH |
|------|------------|-----------------------|--------|----------|--------|
| 1 | 1SV14CS008 | BHARATH P R | M | IV YEAR | CSE |
| 2 | 1SV14CS009 | BHARATHA C HEGADE | M | IV YEAR | CSE |
| 3 | 1SV17IS004 | SANTHOSHBHARADWAJ H A | M | II YEAR | IS |
| 4 | 1SV15IS009 | NARASIMHAMURTHY N | M | III YEAR | IS |
| 5 | 1SV15CS034 | KIRAN A S | M | IV YEAR | CSE |
| 6 | 1SV15CS035 | KUMAR DAHAL | M | IV YEAR | CSE |
| 7 | 1SV14CS036 | MIDHILA MURALI | M | III YEAR | CSE |
| 8 | 1SV15CS001 | ADITYA SHAH | M | III YEAR | CSE |
| 9 | 1SV17CS002 | ABHISHEK PANDEY | M | II YEAR | CSE |
| 10 | 1SV17CS004 | AMAN PRASAD KALWAR | M | II YEAR | CSE |



Physical Education Director.
Dept. of Physical Education.
Shridevi Institute of Engineering & Technology
Sira Road, Tumkur-572106



SHRIDEVI INSTITUTE OF
ENGINEERING AND TECHNOLOGY
TUMKUR - 572106.

1ST PLACE

| CAROM | | | | | |
|-------|------------|-----------------------|--------|---------|--------|
| SLNO | USN | NAME OF THE STUDENT | GENDER | YEAR | BRANCH |
| 1 | 1SV17CS001 | ABHISHEK KUMAR PRASAD | M | II YEAR | CSE |
| 2 | 1SV17IS004 | SANTHOSHBHARADWAJ H A | M | II YEAR | IS |

2ND PLACE

| CAROM | | | | | |
|-------|------------|---------------------|--------|---------|--------|
| SLNO | USN | NAME OF THE STUDENT | GENDER | YEAR | BRANCH |
| 1 | 1SV16EC404 | CHIRANJEEVI K M | M | IV YEAR | ECE |
| 2 | 1SV17EC011 | RAKESH K L | M | II YEAR | ECE |

1ST PLACE

| CAROM | | | | | |
|-------|------------|---------------------|--------|----------|--------|
| SLNO | USN | NAME OF THE STUDENT | GENDER | YEAR | BRANCH |
| 1 | 1SV16EC414 | SOWNDARYA A | F | IV YEAR | ECE |
| 2 | 1SV15EC027 | NOOR AYESHA | F | III YEAR | ECE |

2ND PLACE

| CAROM | | | | | |
|-------|------------|---------------------|--------|---------|--------|
| SLNO | USN | NAME OF THE STUDENT | GENDER | YEAR | BRANCH |
| 1 | 1SV17MBA28 | THIVENI B M | F | II YEAR | MBA |
| 2 | 1SV17MBA09 | HELEN SUPRIYA S | F | II YEAR | MBA |



Physical Education Director.
Dept. of Physical Education.
Shridevi Institute of Engineering & Technology
Sira Road, Tumkur-572106

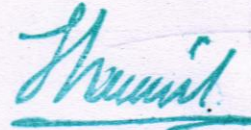

PRINCIPAL
SHRIDEVI INSTITUTE OF
ENGINEERING AND TECHNOLOGY
TUMKUR - 572106

1ST PLACE

| CHESS | | | | | |
|-------|------------|------------------------------|--------|---------|--------|
| SLNO | USN | NAME OF THE STUDENT | GENDER | YEAR | BRANCH |
| 1 | 1SV15CS085 | SHARON BIJU GEORGE | M | IV YEAR | CSE |
| 2 | 1SV15CS048 | MOHAMMED ZUBAIR SIDDIQUE R V | M | IV YEAR | CSE |

2ND PLACE

| CHESS | | | | | |
|-------|------------|---------------------|--------|---------|--------|
| SLNO | USN | NAME OF THE STUDENT | GENDER | YEAR | BRANCH |
| 1 | 1SV17CV013 | PUNITHKUMAR K B | M | II YEAR | CV |
| 2 | 1SV16CV409 | SHIVAYOGI B SALAKI | M | IV YEAR | CV |

1ST PLACE

| CHESS | | | | | |
|-------|------------|-------------------------|--------|---------|--------|
| SLNO | USN | NAME OF THE STUDENT | GENDER | YEAR | BRANCH |
| 1 | 1SV15EC047 | THOSHITHA | F | IV YEAR | ECE |
| 2 | 1SV15EC014 | GEETA RAMESHAPPA HANCHI | F | IV YEAR | ECE |

2ND PLACE

| CHESS | | | | | |
|-------|------------|---------------------|--------|----------|--------|
| SLNO | USN | NAME OF THE STUDENT | GENDER | YEAR | BRANCH |
| 1 | 1SV15EE010 | CHAITHRA C | F | III YEAR | EE |
| 2 | 1SV14EE028 | SPOORTHI H | F | IV YEAR | EE |



Physical Education Director.
 Dept. of Physical Education.
 Shridevi Institute of Engineering & Technology
 Sira Road, Tumkur-572106

PRINCIPAL
 SHRIDEVI INSTITUTE OF
 ENGINEERING AND TECHNOLOGY
 TUMKUR - 572106

1ST PLACE

TABLE TENNIS

| SLNO | USN | NAME OF THE STUDENT | GENDER | YEAR | BRANCH |
|------|------------|-------------------------|--------|---------|--------|
| 1 | 1SV17ME011 | SHIVAGOUD KUMATHALLI | M | II YEAR | ME |
| 2 | 1SV15ME079 | TIRUPATI MOTEPPA RATHOD | M | IV YEAR | ME |

2ND PLACE

TABLE TENNIS

| SLNO | USN | NAME OF THE STUDENT | GENDER | YEAR | BRANCH |
|------|------------|---------------------|--------|---------|--------|
| 1 | 1SV15EC032 | PRASHANT CHOUDRI | M | IV YEAR | ECE |
| 2 | 1SV15EC040 | ROHITH P | M | IV YEAR | ECE |

1ST PLACE

TABLE TENNIS

| SLNO | USN | NAME OF THE STUDENT | GENDER | YEAR | BRANCH |
|------|------------|---------------------|--------|---------|--------|
| 1 | 1SV18EC403 | NIROSHA M V | F | II YEAR | ECE |
| 2 | 1SV14EC015 | LAHARI N RAJ | F | IV YEAR | ECE |

2ND PLCAE

TABLE TENNIS

| SLNO | USN | NAME OF THE STUDENT | GENDER | YEAR | BRANCH |
|------|------------|---------------------|--------|---------|--------|
| 1 | 1SV18MBA25 | RUMANA KHANUM | F | I YEAR | MBA |
| 2 | 1SV17MBA22 | POORNIMA A S | F | II YEAR | MBA |

 Physical Education Director.
 Dept. of Physical Education
 Shridevi Institute of Engineering &
 Sira Road, Tumkur-572106

 PRINCIPAL
 SHRIDEVI INSTITUTE OF
 ENGINEERING AND TECHNOLOGY
 TUMKUR - 572106

PRINCIPAL
 SHRIDEVI INSTITUTE OF
 ENGINEERING AND TECHNOLOGY
 TUMKUR - 572106

**1ST PLACE
HAND BALL**

| SLNO | USN | NAME OF THE STUDENT | GENDER | YEAR | BRANCH |
|------|------------|-----------------------|--------|----------|--------|
| 1 | 1SV15CV048 | SHAIK MEHBOOB SUBHANI | M | IV YEAR | CV |
| 2 | 1SV15CV049 | SHARATH N | M | IV YEAR | CV |
| 3 | 1SV15CV055 | SREE HARI KISHAN | M | IV YEAR | CV |
| 4 | 1SV15CV059 | UMMANNA NAVI | M | IV YEAR | CV |
| 5 | 1SV15CV060 | VENKATESH DESAI | M | IV YEAR | CV |
| 6 | 1SV15CV046 | RAKSHITH R D | M | III YEAR | CV |
| 7 | 1SV15CV054 | SOMANAGOUDA BIRADAR | M | III YEAR | CV |
| 8 | 1SV14CV046 | VENKATESH N | M | IV YEAR | CV |
| 9 | 1SV17CV019 | SHASHI KUMAR KM | M | II YEAR | CV |
| 10 | 1SV18CV419 | VINAY N K | M | II YEAR | CV |
| 11 | 1SV17CV025 | BLI DAGO EVARISTE | M | II YEAR | CV |

**2ND PLACE
HAND BALL**

| SLNO | USN | NAME OF THE STUDENT | GENDER | YEAR | BRANCH |
|------|------------|-----------------------------|--------|--------|--------|
| 1 | 1SV18CS029 | NANDA T M | M | I YEAR | CSE |
| 2 | 1SV18CS037 | SHASHI BHUSHAN KUMAR | M | I YEAR | CSE |
| 3 | 1SV18CS030 | PAVAN C DURGAD | M | I YEAR | CSE |
| 4 | 1SV18EC017 | PREMKUMAR | M | I YEAR | ECE |
| 5 | 1SV18EC020 | SAMEER BICHAGATTI | M | I YEAR | ECE |
| 6 | 1SV18ME008 | RANGANATH K M | M | I YEAR | ME |
| 7 | 1SV18ME004 | KIRTHEESH R | M | I YEAR | ME |
| 8 | 1SV18CV008 | CHANDRAHASA PATEL. K. A. | M | I YEAR | CV |
| 9 | 1SV18CV029 | ROSHAN MAHATO SINGH. | M | I YEAR | CV |
| 10 | 1SV18CV035 | TEJA. K. G. | M | I YEAR | CV |
| 11 | 1SV18CV025 | PAUL. RANADIVE. | M | I YEAR | CV |



Physical Education Director:
Dept. of Physical Education.
Shridevi Institute of Engineering & Technology,
Sira Road, Tumkur-572106

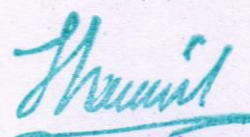

PRINCIPAL
SHRIDEVI INSTITUTE OF
ENGINEERING AND TECHNOLOGY
TUMKUR - 572106

1ST PLACE

FOOT BALL

| SLNO | USN | NAME OF THE STUDENT | GENDER | YEAR | BRANCH |
|------|------------|-----------------------|--------|----------|--------|
| 1 | 1SV16ME409 | MANU K B | M | IV YEAR | ME |
| 2 | 1SV16ME410 | MARUTHI K R | M | IV YEAR | ME |
| 3 | 1SV16ME412 | PRAVEEN P | M | IV YEAR | ME |
| 4 | 1SV16ME413 | PAVAN K S | M | IV YEAR | ME |
| 5 | 1SV17ME004 | KALLESH H D | M | II YEAR | ME |
| 6 | 1SV16ME417 | RAGHAVENDRA B S | M | IV YEAR | ME |
| 7 | 1SV16ME418 | RAGHAVENDRA K | M | IV YEAR | ME |
| 8 | 1SV16ME419 | RAGHAVENDRA MAHADEV N | M | IV YEAR | ME |
| 9 | 1SV15ME086 | YOGESH B V | M | III YEAR | ME |
| 10 | 1SV16ME406 | KHALEELULLA | M | III YEAR | ME |
| 11 | 1SV16ME411 | NITHIN KUMAR J N | M | III YEAR | ME |
| 12 | 1SV16ME415 | PRATHAP R N | M | III YEAR | ME |
| 13 | 1SV14ME011 | BHARATH KALMANE G | M | IV YEAR | ME |
| 14 | 1SV14ME016 | CHETHAN G S | M | IV YEAR | ME |
| 15 | 1SV14ME018 | CHETHAN KUMAR C B | M | IV YEAR | ME |
| 16 | 1SV18ME400 | BHANUPRAKASH | M | II YEAR | ME |

2ND PLACE

FOOT BALL

| SLNO | USN | NAME OF THE STUDENT | GENDER | YEAR | BRANCH |
|------|------------|--------------------------|--------|----------|--------|
| 1 | 1SV17CV007 | HRUTHIK ROHAN N J | M | II YEAR | CV |
| 2 | 1SV17CV023 | UDAY KUMAR GOWDA R V | M | II YEAR | CV |
| 3 | 1SV18CV400 | AJITH KUMAR B N | M | II YEAR | CV |
| 4 | 1SV15CV036 | MANISH CHAUDHARY | M | IV YEAR | CV |
| 5 | 1SV15CV039 | NIRAJ KUMAR CHAUDHARY | M | IV YEAR | CV |
| 6 | 1SV15CV043 | RAJU RIJAL | M | IV YEAR | CV |
| 7 | 1SV16CV413 | MOUNESH S RATHOD | M | IV YEAR | CV |
| 8 | 1SV12CV016 | KISHOR S R | M | IV YEAR | CV |
| 9 | 1SV13CV013 | GEZIT BOY KARAM | M | IV YEAR | CV |
| 10 | 1SV15CV007 | AZIMULLA KHAN D | M | III YEAR | CV |
| 11 | 1SV15CV054 | SOMANAGOUDA BIRADAR | M | III YEAR | CV |
| 12 | 1SV15CV015 | GANESH S D | M | III YEAR | CV |
| 13 | 1SV17CV020 | SHEKHAR MISHRA | M | II YEAR | CV |
| 14 | 1SV17CV008 | JAYAMANJUSH CHOUDRI | M | II YEAR | CV |
| 15 | 1SV17CV010 | LOKESH D | M | II YEAR | CV |
| 16 | 1SV13CV035 | MOIRANGTHEM HEMJIT SINGH | M | IV YEAR | CV |



Physical Education Director.

Dept. of Physical Education.

Shridevi Institute of Engineering & Technology

Sira Road, Tumkur-572106



PRINCIPAL

SHRIDEVI INSTITUTE OF
ENGINEERING AND TECHNOLOGY
TUMKUR - 572106

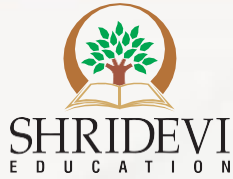

Sri Shridevi Charitable Trust (R.)
SHRIDEVI INSTITUTE OF ENGINEERING & TECHNOLOGY

(Recognised by Govt. of Karnataka, Affiliated to VTU, Belagavi and Approved by AICTE, New Delhi)

Sira Road, Tumakuru - 572 106. Karnataka.

Phone: 0816-2212629 | Fax: 0816-2212628 | Email: info@shrideviengineering.org | Web: http://www.shrideviengineering.org



FS 543667

An ISO 9001:2015 Certified Institution

ANNUAL INTER DEPARTMENT SPORTS COMPETITIONS

CERTIFICATE

This is to certify that Mr. / Ms. ANJAN N

of 1SV14EC002 has secured the 1ST Place

in KHO KHO at the Annual Inter

Department Sports Competitions in the Academic year 2018-19.

RAGHAVENDRA. J
Physical Education Director

Dr. HEMADRI NAIDU. T
Principal, SIET



Sri Shridevi Charitable Trust (R.)
SHRIDEVI INSTITUTE OF ENGINEERING & TECHNOLOGY

(Recognised by Govt. of Karnataka, Affiliated to VTU, Belagavi and Approved by AICTE, New Delhi)

Sira Road, Tumakuru - 572 106. Karnataka.

Phone: 0816-2212629 | Fax: 0816-2212628 | Email: info@shrideviengineering.org | Web: http://www.shrideviengineering.org



FS 543667

An ISO 9001:2015 Certified Institution

ANNUAL INTER DEPARTMENT SPORTS COMPETITIONS

CERTIFICATE

This is to certify that Mr. / Ms. KIRAN A S

of 1SV15CS034 has secured the 2nd Place

in KHO KHO at the Annual Inter

Department Sports Competitions in the Academic year 2018-19.

RAGHAVENDRA. J
Physical Education Director

Dr. HEMADRI NAIDU. T
Principal, SIET

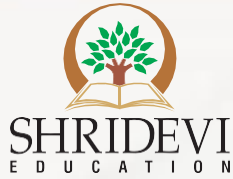

Sri Shridevi Charitable Trust (R.)
SHRIDEVI INSTITUTE OF ENGINEERING & TECHNOLOGY

(Recognised by Govt. of Karnataka, Affiliated to VTU, Belagavi and Approved by AICTE, New Delhi)

Sira Road, Tumakuru - 572 106. Karnataka.

Phone: 0816-2212629 | Fax: 0816-2212628 | Email: info@shrideviengineering.org | Web: http://www.shrideviengineering.org



FS 543667

An ISO 9001:2015 Certified Institution

ANNUAL INTER DEPARTMENT SPORTS COMPETITIONS

CERTIFICATE

This is to certify that Mr. / Ms. SUNITHA Y K

of 1SV15EC045 has secured the 1ST Place

in KHO KHO at the Annual Inter

Department Sports Competitions in the Academic year 2018-19.

RAGHAVENDRA. J
Physical Education Director

Dr. HEMADRI NAIDU. T
Principal, SIET

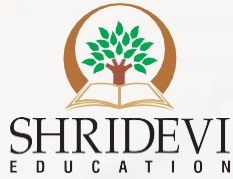

Sri Shridevi Charitable Trust (R.)
SHRIDEVI INSTITUTE OF ENGINEERING & TECHNOLOGY

(Recognised by Govt. of Karnataka, Affiliated to VTU, Belagavi and Approved by AICTE, New Delhi)

Sira Road, Tumakuru - 572 106. Karnataka.

Phone: 0816-2212629 | Fax: 0816-2212628 | Email: info@shrideviengineering.org | Web: http://www.shrideviengineering.org



FS 543667

An ISO 9001:2015 Certified Institution

ANNUAL INTER DEPARTMENT SPORTS COMPETITIONS

CERTIFICATE

This is to certify that Mr. / Ms. POOJA B N

of 1SV18EE403 has secured the 2nd Place

in KHO KHO at the Annual Inter

Department Sports Competitions in the Academic year 2018-19.

RAGHAVENDRA. J
Physical Education Director

Dr. HEMADRI NAIDU. T
Principal, SIET



Sri Shridevi Charitable Trust (R.)

SHRIDEVI INSTITUTE OF ENGINEERING AND TECHNOLOGY

Sira Road, Tumkur - 572 106, Karnataka, India.

Phone: 0816 - 2212629 | Principal: 0816 - 2212627, 9656114839 | Telefax: 0816 - 2212628

Email: info@shrideviengineering.org, principal@shrideviengineering.org | Website: www.shrideviengineering.org

(Approved by AICTE, New Delhi, Recognised by Govt. of Karnataka and Affiliated to Visvesvaraya Technological University, Belagavi)

EXTRA CURRICULAR ACTIVITIES

2018-19



Sri Shridevi Charitable Trust (R.)

SHRIDEVI INSTITUTE OF ENGINEERING AND TECHNOLOGY

Sira Road, Tumkur - 572 106, Karnataka, India.

Phone: 0816 - 2212629 | Principal: 0816 - 2212627, 9656114899 | Telefax: 0816 - 2212628

Email: info@shrideviengineering.org, principal@shrideviengineering.org | Website: www.shrideviengineering.org

(Approved by AICTE, New Delhi, Recognised by Govt. of Karnataka and Affiliated to Visvesvaraya Technological University, Belagavi)

SHRI UTSAV SPORTS

Shridevi Institute of Engineering and Technology has conducted ShriUtsav Sports on 22.03.2019. In this event students from different branches were participated. The event was judged by RAGHAVENDRA JATTENAVAR Physical Education Director of the institution based on which results were announced.

WINNERS LIST OF THE EVENTS

Shridevi Institute of Engineering & Technology
 Sira Road, Tumkur-06
 Department of Physical Education & Sports



| CRICKET (BOYS) WINNERS | | | | CRICKET (BOYS) RUNNERS | | | |
|------------------------|-------------------|--------|-----|------------------------|-----------------|--------|-----|
| SL.NO | Name of Student | Branch | Sem | SL.NO | Name of Student | Branch | Sem |
| 1 | Shaik Subhani | CIVIL | 8 | 1 | Anil Kumar D | MBA | |
| 2 | Pavan O | CIVIL | 8 | 2 | Anil Kumar R S | MBA | |
| 3 | Lakshmi Sagar (C) | CIVIL | 6 | 3 | Lohith | MBA | |
| 4 | Rahul M | CIVIL | 8 | 4 | Clinton | MBA | |
| 5 | Ummanna Nayi | CIVIL | 8 | 5 | Bharath T S | MBA | |
| 6 | Somanagouda | CIVIL | 6 | 6 | Chethan | MBA | |
| 7 | Raviteju M | CIVIL | 4 | 7 | Sharath Kumar | MBA | |
| 8 | Rakshith J | CIVIL | 6 | 8 | Sandeep | MBA | |
| 9 | Ajith Kumar | CIVIL | 4 | 9 | Naveen B L | MBA | |
| 10 | Rakshith R D | CIVIL | 6 | 10 | Nagesh H | MBA | |
| 11 | Venkatesh N | CIVIL | 8 | 11 | Pavan Kumar S | MBA | |
| 12 | Anish Upadhye | CIVIL | 8 | | | | |

| | | | | | | | |
|----|------------------|----|---|----|-------------------|--|---|
| 3 | Rasool Sab Attar | ME | 8 | 3 | Shivamurti | | 2 |
| 4 | Mahesh Banakar | ME | 8 | 4 | Rakesh | | 2 |
| 5 | Vinod T H | ME | 8 | 5 | Nagesh D R | | 2 |
| 6 | Avinash N | ME | 8 | 6 | Basavaraj | | 2 |
| 7 | Ramesh S | ME | 6 | 7 | Bharath | | 2 |
| 8 | Shivangouda | ME | 4 | 8 | Prajwal | | 2 |
| 9 | Ganesh K | ME | 6 | 9 | Sumanth | | 2 |
| 10 | Manoj Kumar V N | ME | 6 | 10 | Vivekanand S Math | | 2 |
| 11 | Govindaraju B N | ME | 8 | 11 | Pavan C D | | 2 |
| 12 | Praveen K | ME | 8 | 12 | Siddu S | | 2 |

| BALL BADMINTON (BOYS) WINNERS | | | | BALL BADMINTON (BOYS) RUNNER | | | |
|-------------------------------|-------------------|--------|-----|------------------------------|-------------------|--------|-----|
| SL.NO | Name of Student | Branch | Sem | SL.NO | Name of Student | Branch | Sem |
| 1 | Ravichandra K (C) | CIVIL | 8 | 1 | Chidambar S | EEE | 6 |
| 2 | Anish Upadhye | CIVIL | 8 | 2 | Kumar Hegde | EEE | 6 |
| 3 | Ummanna Navi | CIVIL | 8 | 3 | Chethan Kumar (C) | EEE | 8 |
| 4 | Rahul M | CIVIL | 8 | 4 | Dileep Kumar B T | EEE | 6 |
| 5 | Raviteja | CIVIL | 4 | 5 | Shivakumar A R | EEE | 4 |
| 6 | Pavan O | CIVIL | 8 | 6 | Chandan Kumar H S | EEE | 6 |
| 7 | Maltesh Karadi | CIVIL | 8 | 7 | Mahesh B | EEE | 4 |
| 8 | Dhanush H M | CIVIL | 8 | 8 | Abhishek L S | EEE | 6 |

| KABBADDI (BOYS) WINNERS | | | | KABBADDI (BOYS) RUNNERS | | | |
|-------------------------|-------------------|--------|-----|-------------------------|--------------------|--------|-----|
| SL.NO | Name of Student | Branch | Sem | SL.NO | Name of Student | Branch | Sem |
| 1 | Rakesh Gowda V S | ME | 2 | 1 | Pradeep P S (C) | ME | 8 |
| 2 | Deekshith R | CSE | 2 | 2 | Shylesh Babu R | ME | 8 |
| 3 | Harshith M S | CIVIL | 2 | 3 | Manoj Kumar V R | ME | 6 |
| 4 | Hiruthvik P | CIVIL | 2 | 4 | Vinod T H | ME | 8 |
| 5 | Arun N R | ECE | 2 | 5 | Harish Kumar K T | ME | 8 |
| 6 | Yashvanth Kumar P | CSE | 2 | 6 | Mahesh Banakar | ME | 8 |
| 7 | Venugopal S V | ME | 2 | 7 | Mahanth Swamy | ME | 8 |
| 8 | Manoj G M | CIVIL | 2 | 8 | Vijay K Patil | ME | 6 |
| 9 | Pavan Kumar | CSE | 2 | 9 | Sagar | ME | 4 |
| 10 | Pavan Nag M A | CIVIL | 2 | 10 | Sohit D Ram | ME | 8 |
| 11 | Ashok Kumar S S | ME | 2 | 11 | Swamy R T | ME | 8 |
| 12 | Hanamesh | CIVIL | 2 | 12 | Vinay Kumar Tirkey | ME | 6 |

| Volley Ball (Boys) Winners | | | | Volley Ball (Boys) Runners | | | |
|----------------------------|-------------------|--------|-----|----------------------------|---------------------|--------|-----|
| SL.NO | Name of Student | Branch | Sem | SL.NO | Name of Student | Branch | Sem |
| 1 | Ganesh K(C) | ME | 6 | 1 | Pavan O (C) | CIVIL | 8 |
| 2 | Jagadeesh K | ME | 8 | 2 | Rakshith R D | CIVIL | 6 |
| 3 | Hanumesh Nayakar | ME | 8 | 3 | Shaik Subhani | CIVIL | 8 |
| 4 | Manoj Kumar V R | ME | 6 | 4 | Ravichandra K | CIVIL | 8 |
| 5 | Manoj Kumar Naik | ME | 8 | 5 | Somanagouda | CIVIL | 6 |
| 6 | Vinod T H | ME | 8 | 6 | Bishwas Dawadi | CIVIL | 8 |
| 7 | Harish Kumar K T | ME | 8 | 7 | Sannakki Chandrashe | CIVIL | 8 |
| 8 | Rasool Sab Attar | ME | 8 | 8 | Puneeth | CIVIL | 4 |
| 9 | Praveen F Kamadol | ME | 8 | 9 | Ummanna Navi | CIVIL | 8 |
| 10 | Shivamurti | ME | 8 | 10 | Rahul M | CIVIL | 8 |
| 11 | Rakesh | ME | 8 | 11 | Deekshith R | CIVIL | 8 |
| 12 | Nagesh D R | ME | 8 | 12 | Basavaraj | CIVIL | 8 |

| KHO KHO (BOYS) WINNERS | | | | KHO KHO (BOYS) RUNNERS | | | |
|------------------------|-------------------|--------|-----|------------------------|--------------------|--------|-----|
| SL.NO | Name of Student | Branch | Sem | SL.NO | Name of Student | Branch | Sem |
| 1 | Tirupati M Rathod | ME | 8 | 1 | Kushal Kumar D (C) | | 2 |
| 2 | Mahanth Swamy | ME | 8 | 2 | Gavi Siddappa B | | 2 |

| CHESS (BOYS) WINNER | | | | CHESS (BOYS) RUNNER | | | |
|---------------------|-----------------|--------|-----|---------------------|-----------------|--------|-----|
| SL.NO | Name of Student | Branch | Sem | SL.NO | Name of Student | Branch | Sem |
| 1 | Raghunath H P | CSE | 8 | 1 | Sachin | EEE | 4 |

| CAROM (BOYS) WINNERS | | | | CAROM (BOYS) RUNNERS | | | |
|----------------------|--|--|--|----------------------|--|--|--|
|----------------------|--|--|--|----------------------|--|--|--|

WINNERS LIST OF THE EVENT

| | | | | | | | |
|----|------------------|----|---|----|-------------------|---|---|
| 3 | Rasool Sab Attar | ME | 8 | 3 | Shivamurti | - | 2 |
| 4 | Mahesh Banakar | ME | 8 | 4 | Rakesh | - | 2 |
| 5 | Vinod T H | ME | 8 | 5 | Nagesh D R | - | 2 |
| 6 | Avinash N | ME | 8 | 6 | Basavaraj | - | 2 |
| 7 | Ramesh S | ME | 6 | 7 | Bharath | - | 2 |
| 8 | Shivangouda | ME | 4 | 8 | Prajwal | - | 2 |
| 9 | Ganesh K | ME | 6 | 9 | Sumanth | - | 2 |
| 10 | Manoj Kumar V N | ME | 6 | 10 | Vivekanand S Math | - | 2 |
| 11 | Govindaraju B N | ME | 8 | 11 | Pavan C D | - | 2 |
| 12 | Praveen K | ME | 8 | 12 | Siddu S | - | 2 |

| SL.NO | Name of Student | Branch | Sem | SL.NO | Name of Student | Branch | Sem |
|-------|-----------------|--------|-----|-------|-------------------|--------|-----|
| 1 | Chethan Kumar | EEE | 8 | 1 | Puneeth Kumar K B | CIVIL | 4 |
| 2 | Kumar Hegde | EEE | 6 | 2 | Rakesh S | CIVIL | 4 |

BALL BADMINTON (BOYS) WINNERS

| SL.NO | Name of Student | Branch | Sem | SL.NO | Name of Student | Branch | Sem |
|-------|-------------------|--------|-----|-------|-------------------|--------|-----|
| 1 | Ravichandra K (C) | CIVIL | 8 | 1 | Chidambar S | EEE | 6 |
| 2 | Anish Upadhye | CIVIL | 8 | 2 | Kumar Hegde | EEE | 6 |
| 3 | Ummanna Navi | CIVIL | 8 | 3 | Chethan Kumar (C) | EEE | 8 |
| 4 | Rahul M | CIVIL | 8 | 4 | Dileep Kumar B T | EEE | 6 |
| 5 | Raviteja | CIVIL | 4 | 5 | Shivkumar A R | EEE | 4 |
| 6 | Pavan O | CIVIL | 8 | 6 | Chandan Kumar H S | EEE | 6 |
| 7 | Maltesh Karadi | CIVIL | 8 | 7 | Mahesh B | EEE | 4 |
| 8 | Dhanush H M | CIVIL | 8 | 8 | Abhishek L S | EEE | 6 |

Volley Ball (Boys) Winners

| SL.NO | Name of Student | Branch | Sem | SL.NO | Name of Student | Branch | Sem |
|-------|--------------------|--------|-----|-------|---------------------|--------|-----|
| 1 | Ganesh K(C) | ME | 6 | 1 | Pavan O (C) | CIVIL | 8 |
| 1 | Jagadeesh K | ME | 8 | 2 | Rakshit R D | CIVIL | 6 |
| 2 | Hanumesh Nayakar | ME | 8 | 3 | Shaik Subhani | CIVIL | 8 |
| 3 | Manoj Kumar V N | ME | 6 | 4 | Ravichandra K | CIVIL | 8 |
| 4 | Manoj Kumar Naik | ME | 8 | 5 | Somanagouda | CIVIL | 6 |
| 5 | Vinod T H | ME | 8 | 6 | Bishwas Dawadi | CIVIL | 8 |
| 6 | Harish Kumar K T | ME | 8 | 7 | Sannakki Chandrashe | CIVIL | 8 |
| 7 | Rasool Sab Attar | ME | 8 | 8 | Puneeth | CIVIL | 4 |
| 8 | Praveen F Kamadoll | ME | 8 | 9 | Ummanna Navi | CIVIL | 8 |
| 9 | Shivraj Y. C | ME | 8 | 10 | Rahul | CIVIL | 8 |
| 10 | Rahul | ME | 8 | 11 | Rahul | CIVIL | 8 |
| 11 | Rahul | ME | 8 | 12 | Rahul | CIVIL | 8 |

CHESS (BOYS) WINNER

| SL.NO | Name of Student | Branch | Sem | SL.NO | Name of Student | Branch | Sem |
|-------|-----------------|--------|-----|-------|-----------------|--------|-----|
| 1 | Raghunath H P | CSE | 8 | 1 | Sachin | EEE | 4 |

CHESS (BOYS) RUNNER

CAROM (BOYS) WINNERS

CAROM (BOYS) RUNNERS

WINNERS LIST OF THE EVENTS



Shridevi Institute of Engineering & Technology

Sira Road, Tumkur-06

Department of Physical Education & Sport



| BALL BADMINTON (GIRLS) WINNERS | | | | BALL BADMINTON (GIRLS) RUNNERS | | | |
|--------------------------------|-------------------|--------|-----|--------------------------------|-----------------|--------|-----|
| SL.NO | Name of Student | Branch | Sem | SL.NO | Name of Student | Branch | Sem |
| 1 | Prathibha B T (C) | CSE | 8 | 1 | Sindhu K N | ME | 8 |
| 2 | Chandana H | CSE | 8 | 2 | Chandana S N | ME | 4 |
| 3 | Bhoomika B S | ISE | 8 | 3 | Komala C M (C) | ME | 8 |
| 4 | Tejashree N | ISE | 8 | 4 | Sahana | ME | 8 |
| 5 | Varshitha R | ISE | 8 | 5 | Amrutha M | ME | 8 |
| 6 | Kavya M | CSE | 8 | 6 | Prabhavathi B R | ME | 4 |
| 7 | Asha T R | CSE | 8 | 7 | Sneha T N | ME | 8 |
| 8 | Anushree K S | CSE | 8 | | | | |

| Volley Ball (Girls) Winners | | | | Volley Ball (Girls) Runners | | | |
|-----------------------------|-------------------|--------|-----|-----------------------------|------------------|--------|-----|
| SL.NO | Name of Student | Branch | Sem | SL.NO | Name of Student | Branch | Sem |
| 1 | Keerthana S N (C) | CSE | 8 | 1 | Sindhu K N | ME | 8 |
| 2 | Bhoomika B S | ISE | 8 | 2 | Chandana S M (C) | ME | 8 |
| 3 | Tejashree N | ISE | 8 | 3 | Komala C M | ME | 8 |
| 4 | Varshitha R | ISE | 8 | 4 | Sahana | ME | 8 |
| 5 | Disha S D | CSE | 8 | 5 | Amrutha M | ME | 8 |
| 6 | Vimala T | CSE | 8 | 6 | Prabhavathi B R | ME | 4 |
| 7 | Anushree K S | CSE | 8 | 7 | Sneha T N | ME | 8 |
| 8 | Pooja C M | CSE | 8 | | | | |
| 9 | Sushmitha | CSE | 6 | | | | |
| 10 | Prathibha B. T | CSE | 8 | | | | |
| 11 | Asha. T. R | CSE | 8 | | | | |
| 12 | Chandana. H | CSE | 8 | | | | |

| THROW BALL (GIRLS) WINNERS | | | | THROW BALL (GIRLS) WINNERS | | | |
|----------------------------|-----------------|--------|-----|----------------------------|-----------------|--------|-----|
| SL.NO | Name of Student | Branch | Sem | SL.NO | Name of Student | Branch | Sem |
| 1 | Sindhu K N (C) | ME | 8 | 1 | Bhavya H P | CSE | 2 |
| 2 | Chandana S M | ME | 4 | 2 | Sindhu K S | CSE | 2 |
| 3 | Komala C M | ME | 8 | 3 | Enchara M | CSE | 2 |
| 4 | Sahana | ME | 8 | 4 | Pragna H S | CSE | 2 |
| 5 | Amrutha | ME | 8 | 5 | Nanda T M | CSE | 2 |
| 6 | Prabhavathi B R | ME | 4 | 6 | Rachana S R | ECE | 2 |

| | | | | | | | |
|----|--------------|-----|---|----|-----------------|-------|---|
| 7 | Sneha T N | ME | 8 | 7 | Jayashree P | CIVIL | 2 |
| 8 | Chandrika S | EEE | 4 | 8 | Amulya J M | CSE | 2 |
| 9 | Divya B J | EEE | 8 | 9 | Hadaamal Khan | CSE | 2 |
| 10 | Shwetha J | EEE | 8 | 10 | Gagana N | CSE | 2 |
| 11 | Vidyashree P | EEE | 8 | 11 | Marlisa Fathima | CSE | 2 |
| 12 | Chaitra C | EEE | 8 | 12 | Priyanka M D | CIVIL | 2 |

| KHO KHO (GIRLS) WINNERS | | | | KHO KHO (GIRLS) RUNNERS | | | |
|-------------------------|-------------------|--------|-----|-------------------------|-----------------|--------|-----|
| SL.NO | Name of Student | Branch | Sem | SL.NO | Name of Student | Branch | Sem |
| 1 | Prathibha B T (C) | CSE | 8 | 1 | Raksha K R | CIVIL | - |
| 2 | Keerthana S N | CSE | 8 | 2 | Tanuja N | CIVIL | - |
| 3 | Tejashree N | ISE | 8 | 3 | Sindhushree H N | CIVIL | - |
| 4 | Bhoomika B S | ISE | 8 | 4 | Sindhu S | CIVIL | - |
| 5 | Varshitha R | ISE | 8 | 5 | Varnana G (C) | CIVIL | - |
| 6 | Chethana K S | ISE | 8 | 6 | Lavanya B R | CIVIL | - |
| 7 | Nikitha M | CSE | 6 | 7 | Ramya | CIVIL | - |
| 8 | Kavya M | CSE | 8 | 8 | Anusha M | CIVIL | - |
| 9 | Sushmitha | CSE | 6 | 9 | Sanjana | CIVIL | - |
| 10 | Varshitha R M | CSE | 6 | 10 | Vanitha | CIVIL | - |
| 11 | Nishchitha K | CSE | 8 | 11 | Sowmya | CIVIL | - |
| 12 | Vimala T | CSE | 8 | 12 | Shobha C | CIVIL | - |

| CRICKET (GIRLS) WINNERS | | | | CRICKET (GIRLS) RUNNERS | | | |
|-------------------------|---------------------|--------|-----|-------------------------|-----------------|--------|-----|
| SL.NO | Name of Student | Branch | Sem | SL.NO | Name of Student | Branch | Sem |
| 1 | Nagapooja J | CIVIL | | 1 | Sindhu K N | ME | 8 |
| 2 | Komala Rani M V (C) | CIVIL | | 2 | Chandana S M | ME | 4 |
| 3 | Sindhu S | CIVIL | | 3 | Komala C M | ME | 8 |
| 4 | Sindhushree H N | CIVIL | | 4 | Sahana (C) | ME | 8 |
| 5 | Shobha C | CIVIL | | 5 | Amrutha M | ME | 8 |
| 6 | Raksha K R | CIVIL | | 6 | Prabhavathi B R | ME | 4 |
| 7 | Sanjana | CIVIL | | 7 | Sneha T N | ME | 8 |
| 8 | Ramya | CIVIL | | 8 | Shwetha J | EEE | 8 |
| 9 | Vamana G | CIVIL | | 9 | Divya B J | EEE | 8 |
| 10 | Tanuja N | CIVIL | | 10 | Amrutha | EEE | 8 |
| 11 | Lavanya B R | CIVIL | | 11 | Chaitra C | EEE | 8 |
| 12 | Vanitha | CIVIL | | 12 | Vidyashree P | EEE | 8 |

| SL.NO | Name of Student | Branch | Sem | SL.NO | Name of Student | Branch | Sem |
|-------|-----------------|--------|-----|-------|-----------------|--------|-----|
| | | | | | | | |

CHESS (GIRLS) WINNER

CHESS (GIRLS) RUNNER

WINNERS LIST OF THE EVENTS



Shridevi Institute of Engineering & Technology

Sira Road, Tumkur-06

Department of Physical Education & Sport



| BALL BADMINTON (GIRLS) WINNERS | | | | BALL BADMINTON (GIRLS) RUNNERS | | | |
|--------------------------------|-------------------|--------|-----|--------------------------------|-----------------|--------|-----|
| SL.NO | Name of Student | Branch | Sem | SL.NO | Name of Student | Branch | Sem |
| 1 | Prathibha B T (C) | CSE | 8 | 1 | Sindhu K N | ME | 8 |
| 2 | Chandana H | CSE | 8 | 2 | Chandana S N | ME | 4 |
| 3 | Bhoomika B S | ISE | 8 | 3 | Komala C M (C) | ME | 8 |
| 4 | Tejashree N | ISE | 8 | 4 | Sahana | ME | 8 |
| 5 | Varshitha R | ISE | 8 | 5 | Amrutha M | ME | 8 |
| 6 | Kavya M | CSE | 8 | 6 | Prabhavathi B R | ME | 4 |
| 7 | Asha T R | CSE | 8 | 7 | Sneha T N | ME | 8 |
| 8 | Anushree K S | CSE | 8 | | | | |

| Volley Ball (Girls) Winners | | | | Volley Ball (Girls) Runners | | | |
|-----------------------------|-------------------|--------|-----|-----------------------------|------------------|--------|-----|
| SL.NO | Name of Student | Branch | Sem | SL.NO | Name of Student | Branch | Sem |
| | Keerthana S N (C) | CSE | 8 | 1 | Sindhu K N | ME | 8 |
| 1 | Bhoomika B S | ISE | 8 | 2 | Chandana S M (C) | ME | 8 |
| 2 | Tejashree N | ISE | 8 | 3 | Komala C M | ME | 8 |
| 3 | Varshitha R | ISE | 8 | 4 | Sahana | ME | 8 |
| 4 | Disha S D | CSE | 8 | 5 | Amrutha M | ME | 8 |
| 5 | Vimala T | CSE | 8 | 6 | Prabhavathi B R | ME | 4 |
| 6 | Anushree K S | CSE | 8 | 7 | Sneha T N | ME | 8 |
| 7 | Pooja C M | CSE | 8 | | | | |
| 8 | Sushmitha | CSE | 6 | | | | |
| 9 | Prathibha B. T | CSE | 8 | | | | |
| 10 | Asha - T. R | CSE | 8 | | | | |
| 11 | Chandana. H | CSE | 8 | | | | |

| THROW BALL (GIRLS) WINNERS | | | | THROW BALL (GIRLS) WINNERS | | | |
|----------------------------|-----------------|--------|-----|----------------------------|-----------------|--------|-----|
| SL.NO | Name of Student | Branch | Sem | SL.NO | Name of Student | Branch | Sem |
| 1 | Sindhu K N (C) | ME | 8 | 1 | Bhavya H P | CSE | 2 |
| 2 | Chandana S M | ME | 4 | 2 | Sindhu K S | CSE | 2 |
| 3 | Komala C M | ME | 8 | 3 | Enchara M | CSE | 2 |
| 4 | Sahana | ME | 8 | 4 | Pragna H S | CSE | 2 |
| 5 | Amrutha | ME | 8 | 5 | Nanda T M | CSE | 2 |
| 6 | Prabhavathi B R | ME | 4 | 6 | Rachana S R | ECE | 2 |

SNAP SHOTS OF SHRI UTSAV SPORTS EVENT

Sports event is inaugurated by our Sri.M.SPatil, Director, HR & IT, Sri Shridevi Charitable Trust® and our bellowed principal .Dr. Hemadri Naidu, Principal, SIET, HOD's of various department and staff members of different department.





Sri Shridevi Charitable Trust (R.)

SHRIDEVI INSTITUTE OF ENGINEERING AND TECHNOLOGY

Sira Road, Tumkur - 572 106, Karnataka, India.

Phone: 0816 - 2212629 | Principal: 0816 - 2212627, 9656114899 | Telefax: 0816 - 2212628

Email: info@shrideviengineering.org, principal@shrideviengineering.org | Website: www.shrideviengineering.org

(Approved by AICTE, New Delhi, Recognised by Govt. of Karnataka and Affiliated to Visvesvaraya Technological University, Belagavi)

INAUGURATION OF SHRI UTSAV



Cultural fest “ Shriustav “- 2019 was Inaugurated in our campus on 29th March 2019, in our campus, the Inauguration of the event was done Dr. Nagendra Prasad, Director, Actor. Kannada Cinema in the presence of Honourable Chairman Dr. M R Hulinaykar, Trustee, SCT, Smt. ShanthaDurgadevi Trustee, SCT, Dr. Raman M Hulnaykar, Medical Director, SIMS & RH, Sri. M S Patil, Director HR & IT, SCT.. Dr. Hemadri Naidu, Principal .HODs, Staff and Students in the open air theatre.

Various cultural events were conducted and were of great success. More than 1000 students actively participated in cultural events. The two days were preceded by a week filled with events where students actively coordinated and took part in. A cultural procession was carried from the Main Entrance to the open air theatre with all of the college in presence as the audience including the Principal and trustees and faculty. An various events was organised such as Solo Dance, Group Dance, Fashion Show, Fireless Cooking, Mehndi, Rangaloi, College Musical Band was performed in the event. Lazy dance was most attractive programme in the event and Singing, Skit, Mime, Photography events was organised by our students only.

Along with various competitions the students of SIET organised DJ Night by ALL OK, famous singer in kannada Cine Industry in the second day evening. The 2 movie promotion team visited the event and performed on the stage and an International well known Judges came to judge the events such as Fashion Show and Dance, all of which received great response from the audience The student and faculty coordinators of different departments have actively organized each event of SanchalanaThe conveners of Sriustav - 2019 were Prof.AijazAhamedSharief& HOD of ECE coordinator .Each department was actively involved in the success of Sriustav 2019.

SNAP SHOT OF INVITATION



SHRIDEVI
EDUCATION

Sri Shridevi Charitable Trust (R.)
SHRIDEVI INSTITUTE OF ENGINEERING & TECHNOLOGY
(Recognised by Govt. of Karnataka, Affiliated to VTU, Belagavi and Approved by AICTE, New Delhi)
Sira Road, Tumakuru - 572 106, Karnataka.

The Management, Principal, HODs, Staff and Students
Cordially Invite you for

Inauguration

 ಶ್ರೀಉತ್ಸವ 2019 
SHRIUTSAV 2019 
Redefining Celebration.....

Presided by
Dr. M. R. HULINAYKAR
Chairman & Managing Trustee,
Sri Shridevi Charitable Trust (R), Tumakuru

Chief Guest
KUM. BHARATHI B. L.
International Athlete &
Vice President, Karnataka Athletics Association,
Bengaluru

Guest of Honour
Sri. M. S. PATIL
Director - HR & IT, SCT, Tumakuru

बेटी बचाओ
Save Girl Child

CHAMPION
IN ME

Date: Friday, 29th March, 2019
Venue: Open Air Theatre, SIET
Time: 5:30 PM

Prof. Aijaz Ahamed Sharief
Chief Co-ordinator, Shriutsav 2019

Dr. Hemadri Naidu T.
Principal

Management, Principal, HODs, Staff and Students of SIET

EVENT LIST DURING SHRI UTSAV



SHRIUTSAV-2019-29th and 30th March



An ISO 9001:2015 Certified Institution

EVENTS & COORDINATORS DETAILS

| Events | Day & Time | Organizing Dept. | Cultural coordinator Details |
|--|---|------------------|-------------------------------------|
| Start of Ethnic Day by performing pooja to Ganapathi idol, Main entrance | 29 th Full Day 9.00am onwards | EEE | Prof. Ravikumar. G. H-9448945314 |
| 29th March | | | |
| Ethnic Show | 29 th 10.30am-11.30am | EEE | Prof. Ravikumar. G. H-9448945314 |
| Musical Chair for Staff | 29 th 11.30am-11.45am | CSE | Prof. Kiran. G-7353461580 |
| Lagori for girls students | 29 th 11.45am-12.30pm | CSE | Prof. Kiran. G-7353461580 |
| Singing | 29 th 1.30pm-3.00pm | EEE | Prof. Ravikumar. G. H-9448945314 |
| Skit/Mime/Mimicry Mad Adds | 29 th 3.00pm-5.45pm | ECE | Prof. Prabita. D. K-9448471458 |
| Dance | 29 th 6.30pm-9.30pm | CSE | Prof. Kiran. G-7353461580 |
| 30th March | | | |
| Fireless Cooking | 30 th 9.00am-10.15am | Civil+BT | Prof. Vinuthan-8884148325 |
| Rangoli | 30 th 10.30am-11.30am | MBA | Prof. Kokila. N-9886636194 |
| Face painting | 30 th 11.30am-12.30pm | Maths | Prof. Rashmi-8867622343, 9686114915 |
| Finger painting | 30 th 1.30pm-2.30pm | Maths | |
| Mehndi | 30 th 2.30pm-3.30pm | Maths | |
| Quiz | 30 th 3.30pm-5.00pm | Civil | Prof. Vinuthan. R-8884148325 |
| Photography | 30 th 5.00pm-5.30pm | Physics | Prof.(Dr.) Sadashiviah-9980951150 |
| Fashion Show | 30 th 6.30pm-9.00pm | MBA | Prof. Kokila. N-9886636194 |
| For registration & Participation contact above cultural coordinators | | | |

A.A.S
Prof. Aijaz Ahamed Sharief
Asst. Prof. & Head
Dept. of ECE
CHIEF COORDINATOR

Copy to: Honorable Chairman for kind information
Director - HR&IT
Dean - Academics
All HoDs - BT, CSE, ISE, ECE, EEE, ME, CIV, MBA, Physics, Chemistry, Maths,
Physical education, Library, T&P, OS

Hemadri Naidu
Dr. Hemadri Naidu. T
Principal



Sri Shridevi Charitable Trust (R.) SHRIDEVI INSTITUTE OF ENGINEERING AND TECHNOLOGY

Sira Road, Tumkur - 572 106, Karnataka, India.

Phone: 0816 - 2212629 | Principal: 0816 - 2212627, 9656114899 | Telefax: 0816 - 2212628

Email: info@shrideviengineering.org, principal@shrideviengineering.org | Website: www.shrideviengineering.org

(Approved by AICTE, New Delhi, Recognised by Govt. of Karnataka and Affiliated to Visvesvaraya Technological University, Belagavi)



CIRCULARS OF THE EVENT

ETHNIC DAY FLASH MOB

Date: 19/03/2019

CIRCULAR

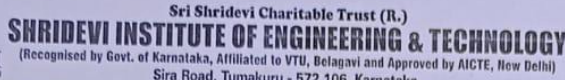
All the students are informed to give their team names on or before Tuesday 26/03/19 for "**ETHNIC DAY FLASH MOB**" which will be held on 29/03/19 at 9-30 am. For more information contact Mahesh; 8722580896 Sachin kumar; 6362812065

Sri Shridevi Charitable Trust (R.)
SHRIDEVI INSTITUTE OF ENGINEERING & TECHNOLOGY
 (Recognised by Govt. of Karnataka, Affiliated to VTU, Belagavi and Approved by AICTE, New Delhi)
 Sira Road, Tumakuru - 572 106, Karnataka.
 Phone: 0816-2212629 | Fax: 0816-2212628 | Email: info@shrideviengineering.org | Web: http://www.shrideviengineering.org

At G. H. Ramani
Dr. H. B. Phani Raju
 H. O. D, EEE Dept

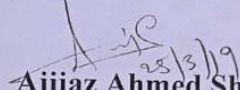

Ajijaz Ahmed Shariff
 (Cultural Coordinator)

10th Sem (Mech) Dr. 25/3/19
 8th Sem (Mech)
 VI Sem (Mech) P. J.
 VI sem (EEE) S. K. P.
 IV sem (Mech) A. P. 25/3/19
 IV sem (CV) 25-3/19
 VIII Sem (CV) 25/3/19
 II sem MBA Grace D. Lakshmi 25/3/19
 II Sem 'C' (Civil & S.M.E) 25/3/19
 II Sem 'A' (ESE) 25/3/19
 II Sem (MBA)

4th Sem - CSE 25/3/19

ETHNIC SHOW

Sri Shridevi Charitable Trust (R.)
SHRIDEVI INSTITUTE OF ENGINEERING & TECHNOLOGY
(Recognised by Govt. of Karnataka, Affiliated to VTU, Belagavi and Approved by AICTE, New Delhi)
Sira Road, Tumakuru - 572 106, Karnataka.
Phone: 0816-2212629 | Fax: 0816-2212628 | Email: info@shrideviengineering.org | Web: http://www.shrideviengineering.org

 
An ISO 9001:2015 Certified Institution

Date: 22/03/2019

CIRCULAR

All the students are informed to give their names on or before Tuesday 26/03/19 for "ETHNIC SHOW" which will be held on 29/03/19 at 11 a.m. For more information contact.

Mahesh; 8722580896
Sachin Kumar; 6362812065

The parameters for the Judges to evaluate upon were:

1. Traditional Formality
2. Colour Coordination
3. Concept Presentation
4. Suitable Accessories
5. Body Language

The following rules are adopted and all are requested to adhere to the rules mention below

1. Use of animals for procession is prohibited during Ethnic day
2. Wheeling of motor cycle is prohibited around the fountain

G. H. B. Phani Raju 22.3.19
Dr. H. B. Phani Raju
H. O. D, EEE Dept

A. S. A. Shariff 22/3/19
Ajjaz Ahmed Shariff
(Cultural Coordinator)

Copy to: All HODs-BT/CSE/EEE/ECE/ME/CIV/MBA/Physics/Chemistry/Maths

SINGING COMPETITION:

 **SHRIDEVI INSTITUTE OF ENGINEERING & TECHNOLOGY, TUMKUR -06**
DEPARTMENT OF ELECTRICAL AND ELECTRONICS ENGINEERING

 An ISO 9001:2015 Certified Institute

Date:- 21/3/2019

CIRCULAR

All the Students here by informed that the Singing Competition will be held on **29th March 2019** Friday Afternoon **2:00pm** at Mechanical Seminar hall block on account of **SHRI UTSAV 2019**. Students willing to participate can give their names to the respective department coordinators of **EEE** on or before 25 March 2019

1. Classical songs
2. Non classical/Film songs
3. Devotional songs
4. Group song

The following rules are adopted and all are requested to adhere to the rules mention below

1. Participant should be present half an hour before the commencement of the Program me
2. The Students should Compulsorily Wear the Id Cards
3. Time Duration 4 to 5 minutes
4. Maximum of 4 participants per team for Group singing.
5. Participants will not be allowed to refer to the lyrics while singing.
6. A final bell will be given at the end of 5 minutes.
7. The participants will be judged on the song selection, voice quality, clarity, rhythm
8. The decision of the judges will be final and binding under all circumstances.
9. Last date of registration is 25th March 2019

H. B. Phani Raju
Dr. H. B. Phani Raju
H. O. D, Dept of EEE

Aijaz
Prof. Aijaz Ahamed Sharief
(Shriustav coordinator)

SKIT, MIME, Mad-Ads, MIMICRY



**SHRIDEVI INSTITUTE OF ENGINEERING
& TECHNOLOGY**



Department of Electronics & Communication & Engineering

SHRIUTSAV - 2019

Date: 21/03/2019

CIRCULAR

It is hereby informed to all the students of SIET that, the following events will be conducted by the Department of Electronics and Communication Engineering in view of **SHRIUTSAV - 2019**. Students who are interested to take part in the various events are hereby informed to contact event coordinator, Prof.D.K.Prabitha (Phone - 9448471458) ECE, Dept, on or before 25th March 2019. Late entries are not allowed. Screening for the various events will be done on 27th March 2019.

Events:- SKIT, MIME, Mad-Ads, MIMICRY

Rules and Regulations:-

Mad-Ads:-

- Maximum of 8 participants per team.
- Time limit is 05 minutes.
- Taking more than the stipulated time will disqualify the team from the competition.
- Judges verdict is the final and binding on all.

SKIT:

- A minimum of 4 and a maximum of 12 participants per team are allowed to participate in this event.
- Maximum time allotted for each team is 15 minutes.
- Use of make-up, drapery and background music is allowed.
- Participating team should submit 1 copy of the synopsis of the theme of skit, along with language of presentation on or before 28th April 2018.
- The skit will be judged basically on the qualities like theme, work on acting, stage craft, design and general impression.
- Vulgarity or bitter insinuations in presentation should be avoided. Only innocent satire or humour is expected. Otherwise the event will be disqualified.

P# 22/03/19

S. 23/3/19

DANCE COMPETATION

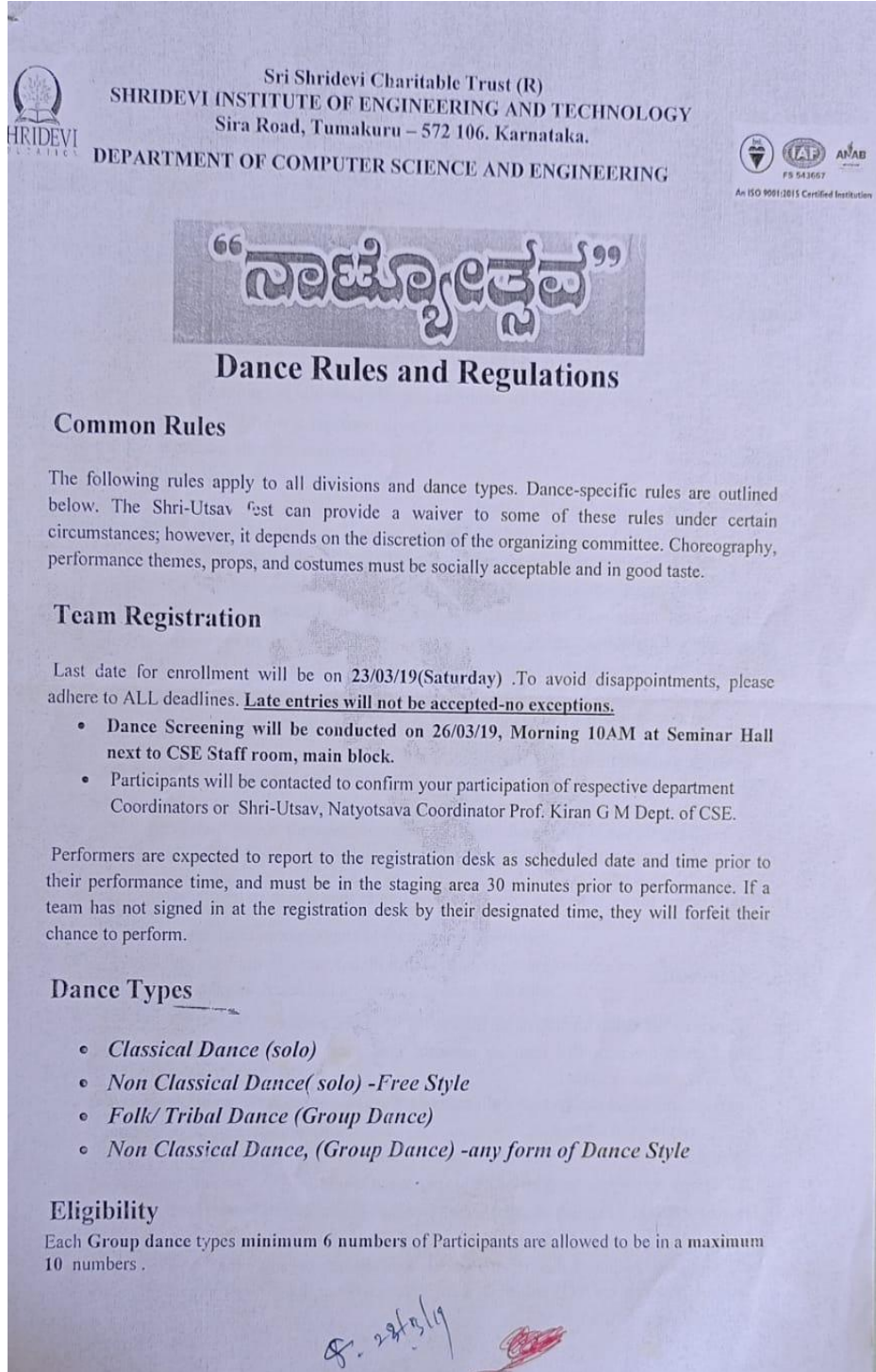

Sri Shridevi Charitable Trust (R)
SHRIDEVI INSTITUTE OF ENGINEERING AND TECHNOLOGY
Sira Road, Tumakuru - 572 106, Karnataka.
DEPARTMENT OF COMPUTER SCIENCE AND ENGINEERING

“ನಾಟ್ಯೋತ್ಸವ”
Dance Rules and Regulations

Common Rules

The following rules apply to all divisions and dance types. Dance-specific rules are outlined below. The Shri-Utsav fest can provide a waiver to some of these rules under certain circumstances; however, it depends on the discretion of the organizing committee. Choreography, performance themes, props, and costumes must be socially acceptable and in good taste.

Team Registration

Last date for enrollment will be on 23/03/19(Saturday) .To avoid disappointments, please adhere to ALL deadlines. Late entries will not be accepted-no exceptions.

- Dance Screening will be conducted on 26/03/19, Morning 10AM at Seminar Hall next to CSE Staff room, main block.
- Participants will be contacted to confirm your participation of respective department Coordinators or Shri-Utsav, Natyotsava Coordinator Prof. Kiran G M Dept. of CSE.

Performers are expected to report to the registration desk as scheduled date and time prior to their performance time, and must be in the staging area 30 minutes prior to performance. If a team has not signed in at the registration desk by their designated time, they will forfeit their chance to perform.

Dance Types

- Classical Dance (solo)
- Non Classical Dance(solo) -Free Style
- Folk/ Tribal Dance (Group Dance)
- Non Classical Dance, (Group Dance) -any form of Dance Style

Eligibility



Each Group dance types minimum 6 numbers of Participants are allowed to be in a maximum 10 numbers .

8. 28/3/19

FIRELESS COOKING

**SHRIDEVI**
EDUCATION

Sri Shridevi Charitable Trust (R.)
SHRIDEVI INSTITUTE OF ENGINEERING & TECHNOLOGY
(Recognised by Govt. of Karnataka, Affiliated to VTU, Belagavi and Approved by AICTE, New Delhi)
Sira Road, Tumakuru - 572 106, Karnataka.
Phone: 0816-2212629 | Fax: 0816-2212628 | Email: info@shrideviengineering.org | Web: http://www.shrideviengineering.org

An ISO 9001:2015 Certified Institution

DEPARTMENT OF CIVIL ENGINEERING

21/03/2019

CIRCULAR

On the Occasion of **SHRIUTSAV-2019**, Department of Civil Engineering / Biotechnology is organizing fireless cooking competition on 30/03/2019 from 9:00am to 10:15am Interested students are hereby informed to enrol their names with the Coordinator of Civil Engineering department on or before 28/03/2019. Late entries will not allowed.

RULES FOR FIRELESS COOKING

1. Maximum of 2 participants per team.
2. Use of fuel is not allowed.
3. One solid food and one liquid food have to be prepared compulsorily.
4. Maximum Time is 40 Minutes.
5. Participants must bring their own utensils and other requirements.
6. Nutritional value of all the ingredients used must be known to the participants.
7. Judgement for fireless cooking is based on nutritional value and taste.
8. Judge decision is final.

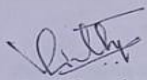
Mr. Vinuthan V.R.
(Fireless Cooking coordinator)

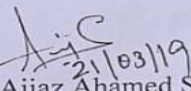
Prof. Aijaz Ahamed Sharief
(Shriustav coordinator)

Copy to:
Principal- For kind information
HOD's: BT/CSE/ISE/ECE/EEE/ME/CV/MBA/ Academic coordinator
for notice board.

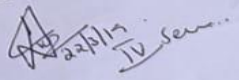

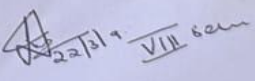

22/3/19 IV Sam

22/3/19 VII Sam

RANGOLI COMPETITION

REDMI NOTE 9
AI QIAD CAMERA

 **SHRIDEVI INSTITUTE OF ENGINEERING & TECHNOLOGY**
(Recognised by Govt. of Karnataka, Affiliated to VTU, Belagavi and Approved by AICTE, New Delhi)
Sira Road, Tumakuru - 572 106, Karnataka.

  
75 SA 5047
AN ISO 9001:2015 Certified Institute

DEPARTMENT OF MBA

Ref: SIET/MBA/2018-2019/01 Date: 18/03/2019

CIRCULAR

"Rangoli Competition" is conducted by the Department of MBA as part of "SHRI UTSAV 2019" function on 30/03/2019 from 10.30am to 11.30 am in front of the Ganesha Statue, Main Entrance.

Interested students are hereby informed to enroll their names with the coordinator Prof. Kokila N N, Department of MBA on or before 25/03/2019.

RULES AND JUDGMENT CRITERIA FOR RANGOLI COMPETITION

Rules:

- 1) A team can have 2 participants.
- 2) Participants should bring their own Rangoli materials.
- 3) Stencils are not allowed.
- 4) Time duration to make the Rangoli design is 1 hour: (10.30 -11.30 am)
- 5) Judges opinion is final for declaration of I & II prize winners.

Judgment Criteria:

1. Overall appearance and appeal.
2. Details and clarity in the design.
3. Color combination.
4. Creativity.

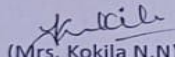

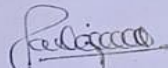
(Mrs. Kokila N.N)
Staff Coordinator

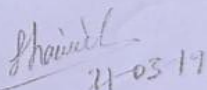
(Dr. K.S. Ramakrishna)
HOD, MBA



(Dr. Hemadri Naidu T)
PRINCIPAL

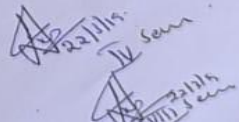

Copy to:

The ShriUtsav-2019 Chief Coordinator, Prof. Aizaz Ahamed Sharief, HOD- ECE Department
HOD's: BT/CSE/ISE/ECE/EEE/MECH/CIVIL/MBA/APPLIED SCIENCE and
Cultural Coordinators of all the departments.



PHOTOGRAPHY COMPETITION

 Sri Shridevi Charitable Trust (R.)
SHRIDEVI INSTITUTE OF ENGINEERING & TECHNOLOGY
(Recognised by Govt. of Karnataka, Affiliated to VTU, Belagavi and Approved by AICTE, New Delhi)
Sira Road, Tumakuru - 572 106, Karnataka.
Phone: 0816-2212629 | Fax: 0816-2212628 | Email: info@shrideviengineering.org | Web: http://www.shrideviengineering.org

  
An ISO 9001:2015 Certified Inst.

Department of Physics

“Save Girl Child” **Date: 21-03-2019**

CIRCULAR

On the occasion of **SHRIUTSAV-2019**, Department of Physics is organizing **Photography** competition on **30-03-2019**. Interested students are hereby informed to enroll their names with the coordinator Dr Sadashivaiah P J, HOD, Department of Physics on or before **25-03-2019**.

Rules and Regulations for Photography competition

- DSLR compulsory.
- Photo should be taken manual photography.
- Edited and downloaded photos not allowed.
- Photos should be taken with in SIET campus from morning to evening on 29th March 2019.
- Shooting of girls photo without permission is prohibited and disqualified.
- 3 Photos allowed for competition.
- Photos should be submitted with in 5:00pm on 30th March 2019.
- The participant has to bring his/her own digital camera of not more than 12 Mega Pixels.
- The digital camera should have a memory card which will be formatted by the judges before the commencement of the contest.
- No mixing, matching or morphing of photographs will be permitted.
- Software such as Photoshop, etc., for enhancing images is not permitted.
- Digital images are evaluated on the basis of
1) Impact 2) composition 3) Technical quality and 4) Suitability for the specified theme.

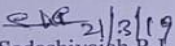
Dr Sadashivaiah P J
(Photography Coordinator)

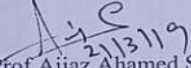
Prof. Aijaz Ahamed Sharief
(Shriutsav Coordinator)

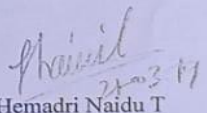
Dr Hemadri Naidu T
(Principal)

Copy to: Principal –For kind information

HODs of : BT/ CSE/ ECE/ EEE/ ISE/ ME/ CV/ MBA/ MATHS/ PHY/ CHEM

QUIZ QUALIFIER TEST

DMI NOTE 9

Sri Shridevi Charitable Trust (R.)
SHRIDEVI INSTITUTE OF ENGINEERING & TECHNOLOGY
(Recognised by Govt. of Karnataka, Affiliated to VTU, Belagavi and Approved by AICTE, New Delhi)
Sira Road, Tumakuru - 572 106, Karnataka.
Phone: 0816-2212629 | Fax: 0816-2212628 | Email: info@shrideviengineering.org | Web: http://www.shrideviengineering.org

DEPARTMENT OF CIVIL ENGINEERING

20/03/2019

CIRCULAR

All the students are hereby informed that the "QUIZ QUALIFIER TEST" will be held on Monday, the 25th March 2019 at 2:30PM at Room No 205 of Administrative block for selecting teams to final round of "QUIZ Competition" on account of SHRIUTSAV-2019. Students willing to participate can give their names to their respective Department coordinator /Head and respective coordinators are informed to forward the names collected to the Quiz competition coordinator Prof. C. Nagaraja, Department of Civil Engineering on or before Saturday, the 23rd March 2019, 10:30 AM. All the HODs and department coordinators are requested to send the names of students early to quiz competition coordinator.

The following procedures are adopted and all are requested to adhere to the rules mentioned below:

- Maximum of Two students per batch must be there for participation. Single student entry is not allowed.
- The test will be for duration of 30 Minutes.
- The students should compulsorily bring the ID cards for appearance in the QUALIFIER TEST.
- Each team of two students will jointly answer the QUIZ QUALIFIER TEST.
- The three teams scoring I, II and III highest marks will be selected for final round.
- The results of QUIZ QUALIFIER TEST will be announced on 26/03/2019.
- The names of students of qualifying teams will be informed to the concerned HOD/ Department coordinators and in turn the HOD / Department coordinators are requested to inform the students for participation at the mentioned time and venue.

Kindly cooperate for smooth conduction of QUALIFIER TEST.

C. Nagaraja
Prof. C. Nagaraja
(Quiz competition coordinator)

Aijaz
Prof. Aijaz Ahamed Sharief
(Shriustav coordinator)

Copy to All the HODs:
HOD's: BT/CSE/ISE/ECE/EEE/ME/CV/MBA/Academic coordinator
for notice board.

Copy to principal for kind information
AHS
20/03/19

A
22/3/19
IV sem
A
20/3/19
III sem



Sri Shridevi Charitable Trust (R.)
SHRIDEVI INSTITUTE OF ENGINEERING AND TECHNOLOGY

Sira Road, Tumkur - 572 106, Karnataka, India.



Phone: 0816 - 2212629 | Principal: 0816 - 2212627, 9656114899 | Telefax: 0816 - 2212628

Email: info@shrideviengineering.org, principal@shrideviengineering.org | Website: www.shrideviengineering.org

(Approved by AICTE, New Delhi, Recognised by Govt. of Karnataka and Affiliated to Visvesvaraya Technological University, Belagavi)

FASHION SHOW EVENT

 **SHRIDEVI INSTITUTE OF ENGINEERING & TECHNOLOGY**
(Recognised by Govt. of Karnataka, Affiliated to VTU, Belagavi and Approved by AICTE, New Delhi)
Sira Road, Tumakuru - 572 106, Karnataka.

  
An ISO 9101:2015 Certified Institution

Department of MBA

Date: 18/03/2019

CIRCULAR

"FASHION SHOW EVENT" is conducted by the Department of MBA as part of "SHRI UTSAV 2019" function on 30/03/2019 at 7.30 pm onwards.

Interested students are hereby informed to enroll their names with the coordinator Prof. KOKILA N.N, Department of MBA on or before 25/03/2019 and also should submit the Music CD's while enrolling their teams. Late entries will not be entertained.

RULES AND REGULATIONS FOR FASHION SHOW

1. Maximum 16 members in a team.
2. One Team per branch+ One team from first year Engineering.
3. Maximum time limit is 8 minutes only.
4. Awkward dress code should be avoided.
5. Two best teams will be given I & II prize. Two best models (1 Male & 1 Female) will be awarded.
6. Each Team should have a Team Name. Eg: Trends-2019

Note: Participants should come with their Identity Numbers.

7. Judges decision is final & binding.
8. **Venue: Open Air Theater.**

Note: Screening for Fashion Show will be on 27/03/2019
Venue: MBA Seminar Hall, Main Building

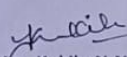
(Ms. Kokila N.N)
Staff Coordinator

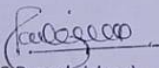
(Dr. K.S. RamaKrishna)
HOD, MBA

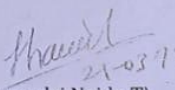
(Dr. Hemadri Naidu T)
PRINCIPAL

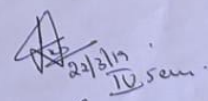
A.P. 27/3/19
10 Sem.

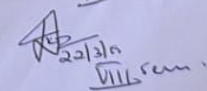
A.P. 27/3/19
VIII Sem.

MEHENDI, FACE PAINTING, FINGER PAINTING

EDMI NOTE 9
QUAD CAMERA

SHRIDEVI INSTITUTE OF ENGINEERING & TECHNOLOGY, TUMKUR-06
(An ISO 9001-2008 Certified Institution)
DEPARTMENT OF MATHEMATICS

CIRCULAR

Date: 25/03/2019

On the occasion of "SHRI UTSAV-2019", Department of Mathematics is organizing

- (i) MEHANDI COMPETATION from 10:30 to 11:30
- (ii) FACE PAINTING from 11:30 to 12:30
- (iii) FINGER PAINTING from 1:30 to 2:30

So the interested students are hereby informed to enroll their name in the Department of Mathematics on or before 27-03-2019.

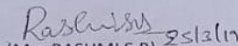
(Mrs. RASHMI S B)
Cultural coordinator

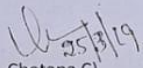
(Dr. Chetana C)
Head of Department

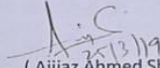
(Aijaz Ahmed Shariff)
Cultural Co-ordinator

Copy to :
Principal-For kind Information
HOD's of : BT/CSE/ECE/EEE/ISE/ME/CV/MBA/PHY/CHEM

SNAPSHOT OF THE CULTURAL EVENT

ETHNIC SHOW AND FLASHMOB EVENT

Cultural fest “ Shriutsav “- 2019 was launched in our campus on 29th March 2019, in our campus, the launching of all cultural was done by our Principal . Dr. Hemadri Naidu with GaneshapoojaHODs, Staff and Students.

A flash mob & Ethnic show was performed by the students in front of the fountain with all of the college in presence as the audience including the Principal and trustees and faculty members. The Sports events such as Volley ball and Throw ball was conducted on the same day with a maximum participation from each department.



SNAP SHOT OF ETHNIC DAY



STUDENTS DANCE IN ETHNIC DAY





Sri Shridevi Charitable Trust (R.)
SHRIDEVI INSTITUTE OF ENGINEERING AND TECHNOLOGY
Sira Road, Tumkur - 572 106, Karnataka, India.

Phone: 0816 - 2212629 | Principal: 0816 - 2212627, 9656114899 | Telefax: 0816 - 2212628

Email: info@shrideviengineering.org, principal@shrideviengineering.org | Website: www.shrideviengineering.org

(Approved by AICTE, New Delhi, Recognised by Govt. of Karnataka and Affiliated to Visvesvaraya Technological University, Belagavi)





INAUGURATION OF SHRIUTSAV-2019





Sri Shridevi Charitable Trust (R.)
SHRIDEVI INSTITUTE OF ENGINEERING AND TECHNOLOGY
Sira Road, Tumkur - 572 106, Karnataka, India.

Phone: 0816 - 2212629 | Principal: 0816 - 2212627, 9656114899 | Telefax: 0816 - 2212628

Email: info@shrideviengineering.org, principal@shrideviengineering.org | Website: www.shrideviengineering.org

(Approved by AICTE, New Delhi, Recognised by Govt. of Karnataka and Affiliated to Visvesvaraya Technological University, Belagavi)

WELCOMING THE GUEST



INAUGURATION BY LIGHTING THE LAMP



HONOURING THE CHIEF GUEST BY SRI M.S. PATIL, DIRECTOR HR & IT



PRIZE DISTRIBUTION BY CHIEF GUEST



PRIZE DISTRIBUTION BY CHIEF GUEST



DANCE BY OUR STUDENTS





Sri Shridevi Charitable Trust (R.)

SHRIDEVI INSTITUTE OF ENGINEERING AND TECHNOLOGY

Sira Road, Tumkur - 572 106, Karnataka, India.

Phone: 0816 - 2212629 | Principal: 0816 - 2212627, 9656114839 | Telefax: 0816 - 2212628

Email: info@shrideviengineering.org, principal@shrideviengineering.org | Website: www.shrideviengineering.org

(Approved by AICTE, New Delhi, Recognised by Govt. of Karnataka and Affiliated to Visvesvaraya Technological University, Belagavi)

SNAPSHOTS OF 2nd DAY SHRIUTSAV

RECEIVING THE CHIEF GUEST BY Dr. M.R. HULINAYKAR , CHAIRMAN AND MANAGING TRUSTEE,SCT



RECEIVING THE CHIEF GUEST BY Dr. M.R. HULINAYKAR , CHAIRMAN AND MANAGING TRUSTEE,SCT



**SPEECH BY HONOURABLE CHAIRMAN
Dr. M.R HULINAYKAR**



PRIZE DISTRIBUTION BY PRINCIPAL



FASHION SHOW IN SHRIUTSAVA-2019





SHRIDEVI
E D U C A T I O N

Sri Shridevi Charitable Trust (R.)

SHRIDEVI INSTITUTE OF ENGINEERING AND TECHNOLOGY

Sira Road, Tumkur - 572 106, Karnataka, India.

Phone: 0816 - 2212629 | Principal: 0816 - 2212627, 9656114899 | Telefax: 0816 - 2212628

Email: info@shrideviengineering.org, principal@shrideviengineering.org | Website: www.shrideviengineering.org

(Approved by AICTE, New Delhi, Recognised by Govt. of Karnataka and Affiliated to Visvesvaraya Technological University, Belagavi)

INDEPENDENSDAY -August 15th



Sri Shridevi Charitable Trust (R.)
SHRIDEVI INSTITUTE OF ENGINEERING AND TECHNOLOGY
 Sira Road, Tumkur - 572 106, Karnataka, India.

Phone: 0816 - 2212629 | Principal: 0816 - 2212627, 9656114899 | Telefax: 0816 - 2212628

Email: info@shrideviengineering.org, principal@shrideviengineering.org | Website: www.shrideviengineering.org

(Approved by AICTE, New Delhi, Recognised by Govt. of Karnataka and Affiliated to Visvesvaraya Technological University, Belagavi)

Shridevi Charitable Trust has conducted Inter collegiate 72nd Independence day on 15.08.2018. The students from different colleges of Shridevi group of institutions participated in various events.

INVITATION OF 72nd INDEPENDENSDAY

ಶ್ರೀ ಶ್ರೀದೇವಿ ಚಾರಿಟಬಲ್ ಟ್ರಸ್ಟ್ (ರ.)

ಶ್ರೀದೇವಿ ಸಮೂಹ ವಿದ್ಯಾಸಂಸ್ಥೆಗಳು

ರಾ.ಹೆ.-4, ಶಿರಾ ರಸ್ತೆ, ತುಮಕೂರು- 572106.

ಧ್ವಜಾರೋಹಣ :
ಡಾ|| ಎಂ. ಆರ್. ಕುಲನಾಯ್ಕರ್
 ಅಧ್ಯಕ್ಷರು, ಶ್ರೀ ಶ್ರೀದೇವಿ ಚಾರಿಟಬಲ್ ಟ್ರಸ್ಟ್ (ರ.)
 ತುಮಕೂರು.

ಅಧ್ಯಕ್ಷತೆ :
ಡಾ|| ರಮಣ್ ಎಂ. ಕುಲನಾಯ್ಕರ್
 ಪ್ರಶ್ನೆ ಮತ್ತು ವೈದ್ಯಕೀಯ ನಿರ್ದೇಶಕರು,
 ಶ್ರೀದೇವಿ ವೈದ್ಯಕೀಯ ಮಹಾವಿದ್ಯಾಲಯ ಮತ್ತು
 ಹಾಗೂ ಆಸ್ಪತ್ರೆ, ತುಮಕೂರು.

ಮುಖ್ಯ ಅತಿಥಿಗಳು :
ಪ್ರೊಫೆಸರ್|| ನಿಧುಲಿಂಗೇ ಗೌಡ
 ಸಂಸ್ಥಾಪಕ ಅಧ್ಯಕ್ಷರು, ವಿಶ್ವ ಮಾಧವ ಜಕ್ಕುಗಲ ಹೋರಾಟಗಾರ
 ಹಾಗೂ ಸಾಮಾಜಿಕ ಹೋರಾಟಗಾರರು, ತುಮಕೂರು.

72ನೇ

ಸ್ವಾತಂತ್ರ್ಯೋತ್ಸವ

ದಿನಾಚರಣೆ

ಧ್ವಜಾರೋಹಣ :
 ಸ್ಥಳ : 15.08.2018, ಬುಧವಾರ, ಬೆಳಿಗ್ಗೆ : 8.30 ಗಂಟೆಗೆ.
 ಸ್ಥಳ : ಶ್ರೀದೇವಿ ಸಮೂಹ ವಿದ್ಯಾಸಂಸ್ಥೆಗಳ ಇವರೂ, ಶಿರಾ ರಸ್ತೆ, ತುಮಕೂರು.

ಸ್ವಾಗತ ಕೋಶವನ್ನು : ಅರಣ್ಯ ಮಂಡಳಿ, ಪ್ರಾಂಶುಪಾಲರು, ಬೋಧಕ ಮತ್ತು ಬೋಧಕೇತರ ಸಜ್ಜಂಥಿ ವಗರ ಹಾಗೂ ವಿದ್ಯಾರ್ಥಿ ವೃಂದ.

GUESTS ARE ARRIVING FOR THE 72nd INDEPENDENSDAY





Sri Shridevi Charitable Trust (R.)
SHRIDEVI INSTITUTE OF ENGINEERING AND TECHNOLOGY
Sira Road, Tumkur - 572 106, Karnataka, India.

Phone: 0816 - 2212629 | Principal: 0816 - 2212627, 9656114899 | Telefax: 0816 - 2212628
Email: info@shrideviengineering.org, principal@shrideviengineering.org | Website: www.shrideviengineering.org
(Approved by AICTE, New Delhi, Recognised by Govt. of Karnataka and Affiliated to Visvesvaraya Technological University, Belagavi)

FLAG HOIST BY THE CHIEF GUEST





Sri Shridevi Charitable Trust (R.)
SHRIDEVI INSTITUTE OF ENGINEERING AND TECHNOLOGY
Sira Road, Tumkur - 572 106, Karnataka, India.

Phone: 0816 - 2212629 | Principal: 0816 - 2212627, 9656114899 | Telefax: 0816 - 2212628
Email: info@shrideviengineering.org, principal@shrideviengineering.org | Website: www.shrideviengineering.org
(Approved by AICTE, New Delhi, Recognised by Govt. of Karnataka and Affiliated to Visvesvaraya Technological University, Belagavi)

MARCH FAST BY THE STUDENTS OF SHRIDEVI CHARITABLE TRUST





Sri Shridevi Charitable Trust (R.)
SHRIDEVI INSTITUTE OF ENGINEERING AND TECHNOLOGY
Sira Road, Tumkur - 572 106, Karnataka, India.

Phone: 0816 - 2212629 | Principal: 0816 - 2212627, 9656114899 | Telefax: 0816 - 2212628

Email: info@shrideviengineering.org, principal@shrideviengineering.org | Website: www.shrideviengineering.org

(Approved by AICTE, New Delhi, Recognised by Govt. of Karnataka and Affiliated to Visvesvaraya Technological University, Belagavi)

BAND TEAM:



MARCHFAST BY STUDENTS OF SHRIDEVI CHARITABLE TRUST:



MARCHFAST BY STUDENTS OF SHRIDEVI CHARITABLE TRUST:



SPEECH BY CHEIEF GUEST





Sri Shridevi Charitable Trust (R.)

SHRIDEVI INSTITUTE OF ENGINEERING AND TECHNOLOGY

Sira Road, Tumkur - 572 106, Karnataka, India.

Phone: 0816 - 2212629 | Principal: 0816 - 2212627, 9656114899 | Telefax: 0816 - 2212628

Email: info@shrideviengineering.org, principal@shrideviengineering.org | Website: www.shrideviengineering.org

(Approved by AICTE, New Delhi, Recognised by Govt. of Karnataka and Affiliated to Visvesvaraya Technological University, Belagavi)

RUBLIC DAY 26TH JANUARY



SHRIDEVI
EDUCATION

Sri Shridevi Charitable Trust (R.)

SHRIDEVI INSTITUTE OF ENGINEERING AND TECHNOLOGY

Sira Road, Tumkur - 572 106, Karnataka, India.

Phone: 0816 - 2212629 | Principal: 0816 - 2212627, 9656114899 | Telefax: 0816 - 2212628

Email: info@shrideviengineering.org, principal@shrideviengineering.org | Website: www.shrideviengineering.org

(Approved by AICTE, New Delhi, Recognised by Govt. of Karnataka and Affiliated to Visvesvaraya Technological University, Belagavi)

RUBLIC DAY 26TH JANUARY

SPORTS EVENT



Sri Shridevi Charitable Trust (R.)
SHRIDEVI INSTITUTE OF ENGINEERING AND TECHNOLOGY

Sira Road, Tumkur - 572 106, Karnataka, India.

Phone: 0816 - 2212629 | Principal: 0816 - 2212627, 9656114899 | Telefax: 0816 - 2212628

Email: info@shrideviengineering.org, principal@shrideviengineering.org | Website: www.shrideviengineering.org

(Approved by AICTE, New Delhi, Recognised by Govt. of Karnataka and Affiliated to Visvesvaraya Technological University, Belagavi)

CURCULAR

SRI SHRIDEVI CHARITABLE TRUST [R.]

SIRA ROAD, TUMKUR-06

Ref: SCT/Adm./Sports/2019

Date: 12.01.2019

CIRCULAR

Sub: Inter collegiate "Republic day Men Volley Ball & Girls Throw Ball Tournament" for Students and Staff "SCT Cup 2019".

We are very happy to inform you that, we are organizing Shridevi Educational Institutional, Inter Collegiate "Republic day Volley Ball/ Throw Ball Tournament "SCT Cup 2019" from 17.01.2019 to 19.01.2019.

All the Principals are requested to send the details of team for students and staff on or before 16.01.2019 @ 10.00 A.M. to Shri.Raghavendra.J / Shri Shashikumar.K

All the Principals are hereby informed to send the team of students (30members) for March-past rehearsals from 22.01.2019 onwards.

Director (HR & IT)
Sri Shridevi Charitable Trust®

For more details contact:

Mr. RAGHAVENDRA.J./SHASHIKUMAR.K

Dept.of Phy. Edu.,

Mob. No: 9880984474/9844091273

Copy submitted to Managing Trustee.

Copy to

1. Medical Director SIMS & RH.
2. All Principals/H.M.
3. Medical Superintendent.
4. Liaison Officer.
5. Trust Office.
6. Physical Education Dept. for necessary arrangements.
7. Notice Board.
8. Office file.
9. Sports file.



To
PED, SBT
from the team
12/1/19

SRI SHRIDEVI CHARITABLE TRUST [R.]

Sira road, Tumkur-572106

70th Republic day Sports Competition-2019

STUDENT'S & STAFF SECTION

SCT CUP 2019

Date: 12.01.2019

A. STUDENT'S SECTION

Boys: Volleyball Match:

Fixtures:

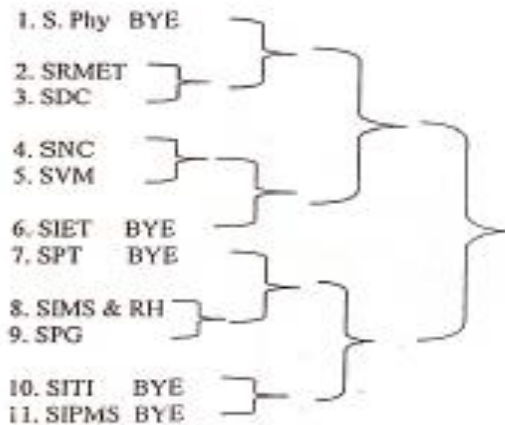

Girls: Volley ball Match:

Fixtures:

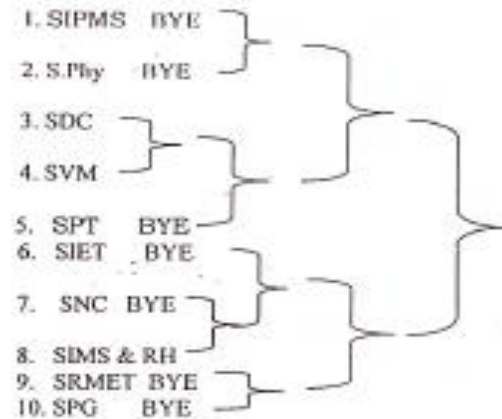

INCHARGE PHYSICAL EDUCATION STAFF:

1. Mr. Raghavendra.J. P.E.D, Ph.No: 9880984474 2. Shashikumar.K, P.E.D, Ph.No:9844091273
3. Mr.Lakshminarayan, Yoga Teacher, Ph.No. 9740668012

Notes:

1. Umpire Decision is final.
2. Team Manger/Lecturer will be accompanied the team
3. Rolling trophy & individual Prize Distribution on 70th Republic Day Programme.

Director (HR & IT)
SCT

Copy submitted to Managing Trustee.

Copy to

1. Medical Director SIMS & RH.
2. All Principals/H.M.
3. Medical Superintendent.
4. Liaison Officer.
5. Trust Office.
6. Physical Education Dept. for necessary arrangements.
7. Notice Board.
8. Office file.
9. Sports file.



Sri Shridevi Charitable Trust (R.)
SHRIDEVI INSTITUTE OF ENGINEERING AND TECHNOLOGY

Sira Road, Tumkur - 572 106, Karnataka, India.

Phone: 0816 - 2212629 | Principal: 0816 - 2212627, 9656114899 | Telefax: 0816 - 2212628

Email: info@shrideviengineering.org, principal@shrideviengineering.org | Website: www.shrideviengineering.org

(Approved by AICTE, New Delhi, Recognised by Govt. of Karnataka and Affiliated to Visvesvaraya Technological University, Belagavi)

B. STAFF SECTION (VOLLEY BALL MEN)

1. SDC & SPG BYE
2. SHS, SRMET
3. SIMS&RH, SNC
4. SPT
5. SIET, SITI
6. S.Phy, SVM, SIMPS BYE

STAFF SECTION (THROW BALL WOMEN)

1. SDC, SPG & S.Phy
2. SIPMS, SIMS & RH
3. SNC, SRMET & SPT
4. SIET, SVM, SHS

Rules:

1. Umpire Decision is final.
2. Team Manger/Lecturer will be accompanied the team.
3. Individual Prize Distribution on 70th Republic Day Programme.

Director (HR & IT)
SCT

Copy submitted to Managing Trustee.

Copy to

1. Medical Director SIMS & RH.
2. All Principals/H.M.
3. Medical Superintendent.
4. Liaison Officer.
5. Trust Office



WINNER LIST:

SPONSOR RESULT 4

I (BOYS STUDENTS)

I Volley Ball Men

II SIPMS

III SDC

II (GIRLS STUDENTS) women

I SPG

II SPT

Merch Post Result
(Mer section)

I SRMET

II SUM High School Boys

(Women section)

I SIPMS

II SUM

III Band

Calicut Classical Result

I SUM

II SPT



SRI SHRIDEVI CHARITABLE TRUST [R.]

Sira road, Tumkur-572106

70th Republic day Sports Competition-2019

STUDENT'S & STAFF SECTION

SCT CUP 2019

Date: 12.01.2019

A. STUDENT'S SECTION

Boys: Volleyball Match:

Fixtures:

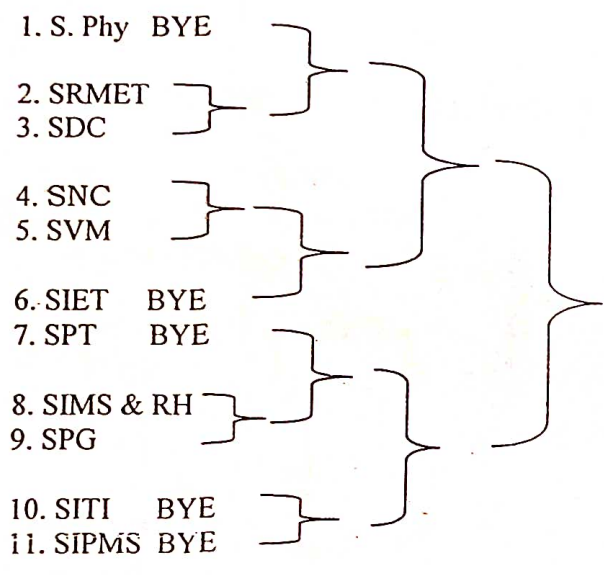

Girls: Volley ball Match:

Fixtures:

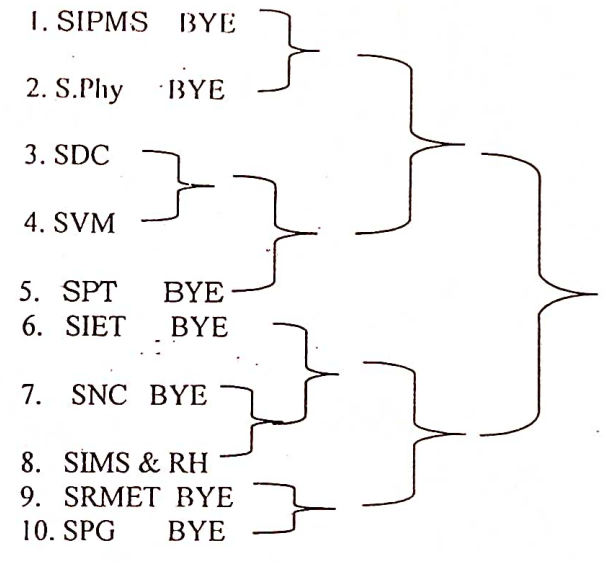

INCHARGE PHYSICAL EDUCATION STAFF:

- 1. Mr. Raghavendra.J. P.E D. Ph.No: 9880984474
- 2. Shashikumar.K, P.E D, Ph.No:9844091273
- 3. Mr.Lakshminarayan, Yoga Teacher, Ph.No. 9740668012

Rules:

- 1. Umpire Decision is final.
- 2. Team Manger/Lecturer will be accompanied the team
- 3. Rolling trophy & individual Prize Distribution on 70th Republic Day Programme.

Director (HR & IT)
SCT

Copy submitted to Managing Trustee.

Copy to

- 1. Medical Director SIMS & RH.
- 2. All Principals/H.M.
- 3. Medical Superintendent.
- 4. Liaison Officer.
- 5. Trust Office.
- 6. Physical Education Dept. for necessary arrangements.
- 7. Notice Board.
- 8. Office file.
- 9. Sports file.

B. STAFF SECTION (VOLLEY BAL MEN)

- 1. SDC & SPG BYE
 - 2. SHS, SRMET
 - 3. SIMS&RH, SNC
 - 4. SPT
 - 5. SIET, SITI
 - 6. S.Phy, SVM, SIMPS BYE
-

STAFF SECTION (THROW BALL WOMEN)

- 1. SDC, SPG & S.Phy
 - 2. SIPMS, SIMS & RH
 - 3. SNC, SRMET & SPT
 - 4. SIET, SVM, SHS
-

Rules:

- 1. Umpire Decision is final.
- 2. Team Manger/Lecturer will be accompanied the team.
- 3. Individual Prize Distribution on 70th Republic Day Programme.

**Director (HR & IT)
SCT**

Copy submitted to Managing Trustee.

Copy to

- 1. Medical Director SIMS & RH.
- 2. All Principals/H.M.
- 3. Medical Superintendent.
- 4. Liaison Officer.
- 5. Trust Office.
- 6. Physical Education Dept. for necessary arrangements.
- 7. Notice Board.
- 8. Office file.
- 9. Sports file.

→ ^{Boys}
(Students)

I Volley Ball Men

I SIPMS

II SDC

II (Girls Students) women

I SPG

II SPT

March Post Results

(New section)

I SAMET

II SUM High School Boys

(Women section)

I SIPMS

II SUM

TBand

Collected

I SUM

II SPT

Current Results